

JVC

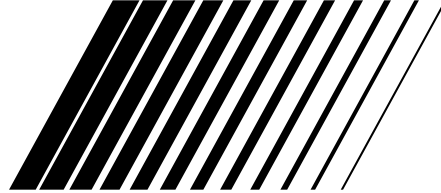

AUDIO/VIDEO CONTROL RECEIVER

RX-8030VBK RX-7030VBK/RX-7032VSL

AV COMPU LINK

COMPU LINK
Remote

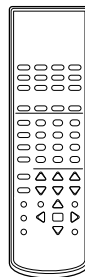
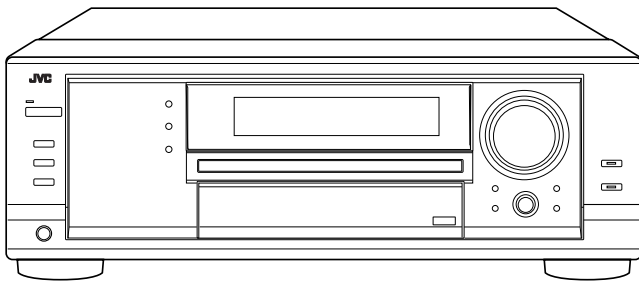

INSTRUCTIONS

For Customer Use:

Enter below the Model No. and Serial No. which are located either on the rear, bottom or side of the cabinet. Retain this information for future reference.

Model No. _____

Serial No. _____

Warnings, Cautions and Others/ Mises en garde, précautions et indications diverses



The lightning flash with arrowhead symbol, within an equilateral triangle is intended to alert the user to the presence of uninsulated "dangerous voltage" within the product's enclosure that may be of sufficient magnitude to constitute a risk of electric shock to persons.



The exclamation point within an equilateral triangle is intended to alert the user to the presence of important operating and maintenance (servicing) instructions in the literature accompanying the appliance.

WARNING: TO REDUCE THE RISK OF FIRE OR ELECTRIC SHOCK, DO NOT EXPOSE THIS APPLIANCE TO RAIN OR MOISTURE.

CAUTION

To reduce the risk of electrical shocks, fire, etc.:

1. Do not remove screws, covers or cabinet.
2. Do not expose this appliance to rain or moisture.

ATTENTION

Afin d'éviter tout risque d'électrocution, d'incendie, etc.:

1. Ne pas enlever les vis ni les panneaux et ne pas ouvrir le coffret de l'appareil.
2. Ne pas exposer l'appareil à la pluie ni à l'humidité.

Caution — STANDBY/ON button!

Disconnect the mains plug to shut the power off completely. The  STANDBY/ON button in any position does not disconnect the mains line. The power can be remote controlled.

Attention — Commutateur STANDBY/ON!

Déconnecter la fiche de secteur pour couper complètement le courant. Le commutateur  STANDBY/ON ne coupe jamais complètement la ligne de secteur, quelle que soit sa position. Le courant peut être télécommandé.

For U.S.A

This equipment has been tested and found to comply with the limits for a Class B digital device, pursuant to part 15 of the FCC Rules. These limits are designed to provide reasonable protection against harmful interference in a residential installation.

This equipment generates, uses and can radiate radio frequency energy and, if not installed and used in accordance with the instructions, may cause harmful interference to radio communications. However, there is no guarantee that interference will not occur in a particular installation. If this equipment does cause harmful interference to radio or television reception, which can be determined by turning the equipment off and on, the user is encouraged to try to correct the interference by one or more of the following measures:

Reorient or relocate the receiving antenna.

Increase the separation between the equipment and receiver.

Connect the equipment into an outlet on a circuit different from that to which the receiver is connected.

Consult the dealer or an experienced radio/TV technician for help.

Changes or modifications not expressly approved by the manufacturer for compliance could void the user's authority to operate the equipment.

Note to CATV system installer:

This reminder is provided to call the CATV system installer's attention to Section 820-40 of the NEC which provides guidelines for proper grounding and, in particular, specifies that the cable ground shall be connected to the grounding system of the building, as close to the point of cable entry as practical.

For Canada/pour Le Canada

CAUTION: TO PREVENT ELECTRIC SHOCK, MATCH WIDE BLADE OF PLUG TO WIDE SLOT, FULLY INSERT

ATTENTION: POUR EVITER LES CHOCS ELECTRIQUES, INTRODUIRE LA LAME LA PLUS LARGE DE LA FICHE DANS LA BORNE CORRESPONDANTE DE LA PRISE ET POUSSER JUSQU'AU FOND

THIS DIGITAL APPARATUS DOES NOT EXCEED THE CLASS B LIMITS FOR RADIO NOISE EMISSIONS FROM DIGITAL APPARATUS AS SET OUT IN THE INTERFERENCE-CAUSING EQUIPMENT STANDARD ENTITLED "DIGITAL APPARATUS," ICES-003 OF THE DEPARTMENT OF COMMUNICATIONS. CET APPAREIL NUMERIQUE RESPECTE LES LIMITES DE BRUITS RADIOELECTRIQUES APPLICABLES AUX APPAREILS NUMERIQUES DE CLASSE B PRESCRITES DANS LA NORME SUR LE MATERIEL BROUILLEUR; "APPAREILS NUMERIQUES", NMB-003 EDICTEE PAR LE MINISTRE DES COMMUNICATIONS.

Table of Contents

| | | | |
|--|-----------|--|-----------|
| Introduction | 2 | Basic Settings | 25 |
| Features | 2 | Setting the Speakers Configuration | 25 |
| Precautions | 2 | Basic Setting Items | 26 |
| Parts Identification | 3 | Basic Procedure | 27 |
| Remote Control | 3 | Setting the Speakers | 27 |
| Front Panel | 4 | Setting the Speaker Distance | 28 |
| Rear Panel | 6 | Setting the Bass Sounds | 28 |
| Getting Started | 8 | Selecting main or sub channel—DUAL MONO | 29 |
| Before Installation | 8 | Setting the Digital Input Terminals | 29 |
| Checking the Supplied Accessories | 8 | Setting the Component Video Input | 30 |
| Putting Batteries in the Remote Control | 8 | Memorizing the Volume Level for Each Source | 30 |
| Connecting the FM and AM Antennas | 8 | Adjusting Sound | 31 |
| Connecting the Speakers | 9 | Basic Setting Items | 31 |
| Connecting Audio/Video Components | 11 | Basic Procedure | 31 |
| ■ Analog Connections | 11 | Adjusting the Equalization Patterns | 32 |
| ■ Digital Connections | 16 | Adjusting the Speaker Output Levels | 32 |
| Connecting the Power Cord | 16 | Adjusting the Sound Parameters for the Surround and DSP modes | 33 |
| Basic Operations | 17 | Using the Surround Modes | 34 |
| Daily Operational Procedure | 17 | Reproducing Theater Ambience | 34 |
| Turning On the Power | 17 | Introducing the Surround Modes | 34 |
| Selecting the Source to Play | 17 | Surround Modes Applicable to the Various Software | 36 |
| Adjusting the Volume | 18 | Activating the Surround Modes | 37 |
| Selecting the Front Speakers | 19 | ■ Activating the EX/ES setting | 37 |
| Activating and Adjusting the Subwoofer Sound | 19 | ■ Activating the Surrounding modes | 37 |
| Selecting the Analog or Digital Input Mode | 19 | Using the DSP Modes | 38 |
| Setting the Dynamic Range | 20 | Reproducing the Sound Field | 38 |
| Attenuating the Input Signal | 20 | Introducing the DSP Modes | 38 |
| Turning Analog Direct On and Off | 21 | Activating the DSP Modes | 39 |
| Making Sounds Natural | 21 | Using the DVD MULTI Playback Mode | 40 |
| Changing the Source Name | 21 | Activating the DVD MULTI Playback Mode | 40 |
| Reinforcing the Bass | 22 | COMPU LINK Remote Control System | 41 |
| Muting the Sound | 22 | AV COMPU LINK Remote Control System ... | 42 |
| Changing the Display Brightness | 22 | Operating JVC's Audio/Video Components ... | 44 |
| Using the Sleep Timer | 22 | Operating Audio Components | 44 |
| Receiving Radio Broadcasts | 23 | Operating Video Components | 46 |
| Tuning in to Stations Manually | 23 | Operating Other Manufacturers' Video Equipment | 47 |
| Using Preset Tuning | 23 | Troubleshooting | 50 |
| Selecting the FM Reception Mode | 24 | Specifications | 51 |



This mark indicates that ONLY the remote control CAN be used for the operation explained.



Features with this mark are provided only for RX-8030VBK.



This mark indicates that the remote control CANNOT be used for the operation explained. Use the buttons on the front panel.



Features with this mark are provided only for RX-7030VBK/RX-7032VSL.

Introduction

We would like to thank you for purchasing one of our JVC products. Before operating this unit, read this manual carefully and thoroughly to obtain the best possible performance from your unit, and retain this manual for future reference.

Features

CC (Compensative Compression) converter **—ONLY for RX-8030VBK**

CC Converter eliminates jitter and ripples, achieving a drastic reduction in digital distortion by processing the digital music data in 24 bit-quantization and by expanding the sampling frequency to 128 kHz (for fs 32 kHz signals)/176.4 kHz (for fs 44.1 kHz signals)/192 kHz (for fs 48 kHz signals). By using the CC Converter, you can obtain a natural sound field from any source. (See page 21 for details.)

K2 technology—ONLY for RX-8030VBK

K2 technology has been designed to enable natural audio reproduction, achieving a drastic reduction in digital distortion and creating original sound ambience with high precision.

Compatible with various audio formats including DTS 96/24

RX-8030VBK and RX-7030VBK/RX-7032VSL allow you to enjoy a newly introduced audio format such as Dolby Digital EX, Dolby Pro Logic II, DTS-ES, DTS Neo:6, and DTS 96/24.

- This unit is also compatible with Dual Mono signals recorded in Dolby Digital and DTS discs.

DAP (Digital Acoustic Processor)

Sound field simulation technology allows precise ambience recreation of existing theaters and halls. Thanks to the high-performance DSP (Digital Signal Processor) and high-capacity memory, you can enjoy multi-channel surround sound by playing 2-channel or multi-channel software according to the speaker setting.

Multi-channel headphone virtual surround sound—3D HEADPHONE Mode

The built-in headphone virtual surround system is compatible with Multi-channel software like Dolby Digital, DTS Surround, etc. Thanks to the new signal processing algorithms used by the high-performance DSP, you can enjoy a natural surround sound through the headphones.

COMPU LINK/AV COMPU LINK remote control systems

These COMPU LINK remote control systems allow you to operate other JVC's audio/video components from this receiver.

Precautions

Power sources

- When unplugging the receiver from the wall outlet, always pull the plug, not the AC power cord.
- Do not handle the AC power cord with wet hands.
- If you are not going to operate the receiver for an extended period of time, unplug the AC power cord from the wall outlet.

Ventilation

High power amplifiers built in this receiver will generate heat inside the cabinet. For safety, observe the following carefully.

- Make sure there is good ventilation around the receiver. Poor ventilation could overheat and damage the receiver.
- Do not block the ventilation openings or holes. (If the ventilation openings or holes are blocked by a newspaper or cloth, etc., the heat may not be able to get out.)

Others

- Should any metallic object or liquid fall onto the unit, unplug the unit and consult your dealer before operating any further.
- Do not expose this apparatus to rain, moisture, dripping or splashing and that no objects filled with liquids, such as vases shall be placed on the apparatus.
- Do not disassemble the unit since there are no user serviceable parts inside.

If anything goes wrong, unplug the AC power cord and consult your JVC dealer.

Remote Control

RX-8030VBK

RX-7030VBK/RX-7032VSL

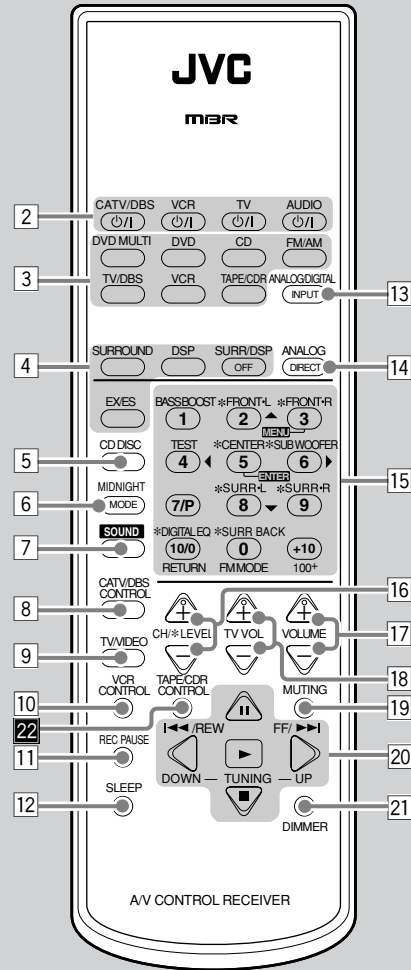
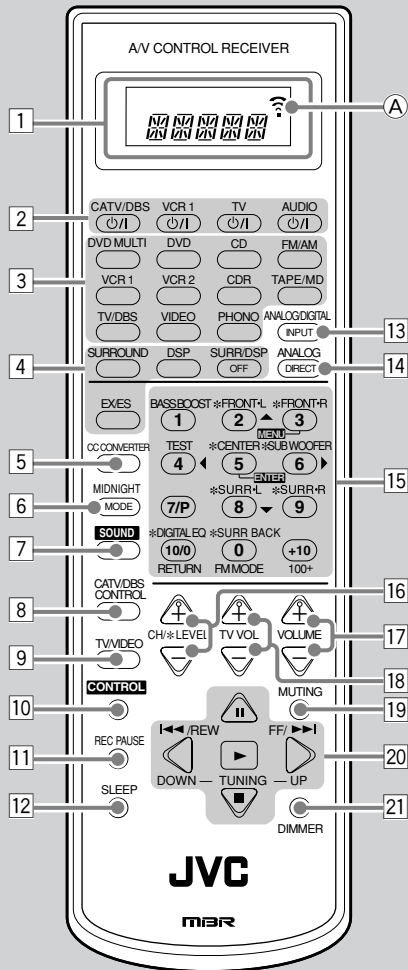

- 1 **Only for RX-8030VBK:** Display window
 - When the remote operation mode changes, it is shown on this display.
 - Signal transmission indicator (A) lights up when transmitting signals.
- 2 ϕ /I buttons (17, 46 – 48)
 - **For RX-8030VBK:**
CATV/DBS ϕ /I, VCR 1 ϕ /I, TV ϕ /I, AUDIO ϕ /I
 - **For RX-7030VBK/RX-7032VSL:**
CATV/DBS ϕ /I, VCR ϕ /I, TV ϕ /I, AUDIO ϕ /I
- 3 Source selection buttons (17, 18, 19, 23, 24, 37, 40)
 - **For RX-8030VBK:**
DVD MULTI, DVD, CD*, FM/AM*, VCR 1, VCR 2, CDR*, TAPE/MD*, TV/DBS, VIDEO, PHONO*
 - **For RX-7030VBK/RX-7032VSL:**
DVD MULTI, DVD, CD*, FM/AM*, TV/DBS, VCR, TAPE/CDR*

* When you press one on these source selection buttons on the remote control, the receiver automatically turns on.
- 4 • SURROUND button (37)
- DSP button (39)
- SURR (surround)/DSP OFF button (37, 39)
- EX/ES button (37)
- 5 • **For RX-8030VBK:** CC CONVERTER button (21)
- **For RX-7030VBK/RX-7032VSL:** CD DISC button (45)
- 6 MIDNIGHT MODE button (20)

- 7 SOUND button (22, 32, 33)
- 8 CATV/DBS CONTROL button (47)
- 9 TV/VIDEO button (46, 47)
- 10 • **For RX-8030VBK:** CONTROL button (44 – 46)
- **For RX-7030VBK/RX-7032VSL:**
VCR CONTROL button (46)
- 11 REC PAUSE button (45, 46, 48)
- 12 SLEEP button (22)
- 13 ANALOG/DIGITAL INPUT button (20)
- 14 ANALOG DIRECT button (21)
- 15 • 10 keys for operating the tuner (24)
- 10 keys for adjusting sound (32, 33)
- 10 keys for operating audio/video components (44 – 48)
- 16 • CH (channel) +/- buttons (46 – 48)
- *LEVEL +/- buttons (32, 33, 44)
- The LEVEL +/- buttons function only after pressing SOUND then 10 keys which are marked with an asterisk (*) on the remote control.*
- 17 VOLUME +/- buttons (18)
- 18 TV VOL (volume) +/- buttons (46, 47)
- 19 MUTING button (22)
- 20 • TUNING UP/DOWN buttons (23)
- Operating buttons for audio/video components (44 – 46, 48)
▶, II, ■, ◀◀/REW, FF/▶▶
- 21 DIMMER button (22)
- 22 **Only for RX-7030VBK/RX-7032VSL:**
TAPE/CDR CONTROL button (45)

Front Panel

- 1 Φ /I STANDBY/ON button and STANDBY lamp (17)
- 2 • SPEAKERS ON/OFF 1 button (19)
• SPEAKERS ON/OFF 2 button (19)
- 3 • SURROUND button (37)
• DSP button (39)
• SURROUND/DSP OFF button (37, 39)
- 4 Remote sensor
- 5 Display window (17)
- 6 • **For RX-8030VBK:** Source selection buttons and lamps (17, 18, 19, 21, 23, 24, 37, 40)
DVD MULTI, DVD, VCR 1, VCR 2, VIDEO,
TV SOUND/DBS, PHONO, CD, CDR, TAPE/MD, FM, AM
(The lamp above the button for selected source lights up.)
• **For RX-7030VBK/RX-7032VSL:** Source selection buttons (17, 18, 19, 21, 23, 24, 37, 40)
DVD MULTI, DVD, VCR, TV SOUND/DBS, CD,
TAPE/CDR, FM, AM
- 7 MASTER VOLUME control (18)
- 8 • **For RX-8030VBK:** CC CONVERTER button and lamp (21)
• **For RX-7030VBK/RX-7032VSL:** BASS BOOST button and lamp (22)
- 9 SUBWOOFER OUT ON/OFF button (19)
- 10 PHONES jack (19)
- 11 EX/ES button (37)
- 12 • INPUT ANALOG button (20)
• INPUT ATT button (20)
- 13 MIDNIGHT MODE button (20)
- 14 INPUT DIGITAL button (20)
- 15 TUNER CONTROL buttons
• FM/AM TUNING \blacktriangle / \blacktriangledown buttons (23)
• FM/AM PRESET \blacktriangle / \blacktriangledown buttons (23, 24)
• FM MODE button (24)
• MEMORY button (23)
- 16 **Only for RX-8030VBK:** VIDEO input jacks (13)
DIGITAL optical terminal, S-VIDEO jack, VIDEO jack,
AUDIO—L/R jacks
- 17 SETTING button (27)
- 18 QUICK SPEAKER SETUP button (25)
- 19 • MULTI JOG control (25, 27, 31)
• PUSH SET button (25, 27, 31)
- 20 EXIT button (27, 31)
- 21 ADJUST button (31)
- 22 ANALOG DIRECT button and lamp (21)

Display Window

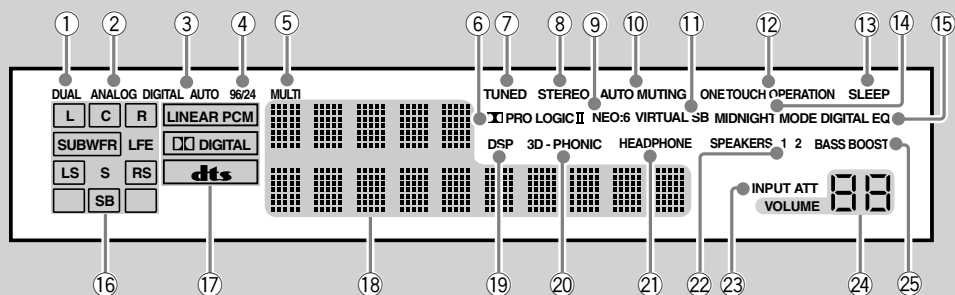

Display Window

- 1 DUAL indicator (35)
- 2 ANALOG indicator (20)
- 3 DIGITAL AUTO indicator (20)
- 4 96/24 indicator (35)
- 5 MULTI indicator (40)
- 6 • \square PRO LOGIC indicator (34)
• \square PRO LOGIC II indicator (35)
- 7 TUNED indicator (23)
- 8 STEREO indicator (23, 24)
- 9 NEO:6 indicator (35)
- 10 AUTO MUTING indicator (24)
- 11 VIRTUAL SB (Surround Back) indicator (34, 35)
- 12 ONE TOUCH OPERATION indicator (30)
- 13 SLEEP indicator (22)
- 14 MIDNIGHT MODE indicator (20)
- 15 DIGITAL EQ (equalization) indicator (32)
- 16 Speaker and signal indicators (18)
- 17 Digital signal format indicators (20)
- 18 Main Display (17)
- 19 DSP indicator (19, 38)
- 20 3D-PHONIC indicator (38)
- 21 HEADPHONE indicator (19, 38)
- 22 SPEAKERS 1/2 indicators (19)
- 23 INPUT ATT (attenuator) indicator (20)
- 24 VOLUME level indicator (17, 22)
- 25 BASS BOOST indicator (22)

Rear Panel

RX-8030VBK

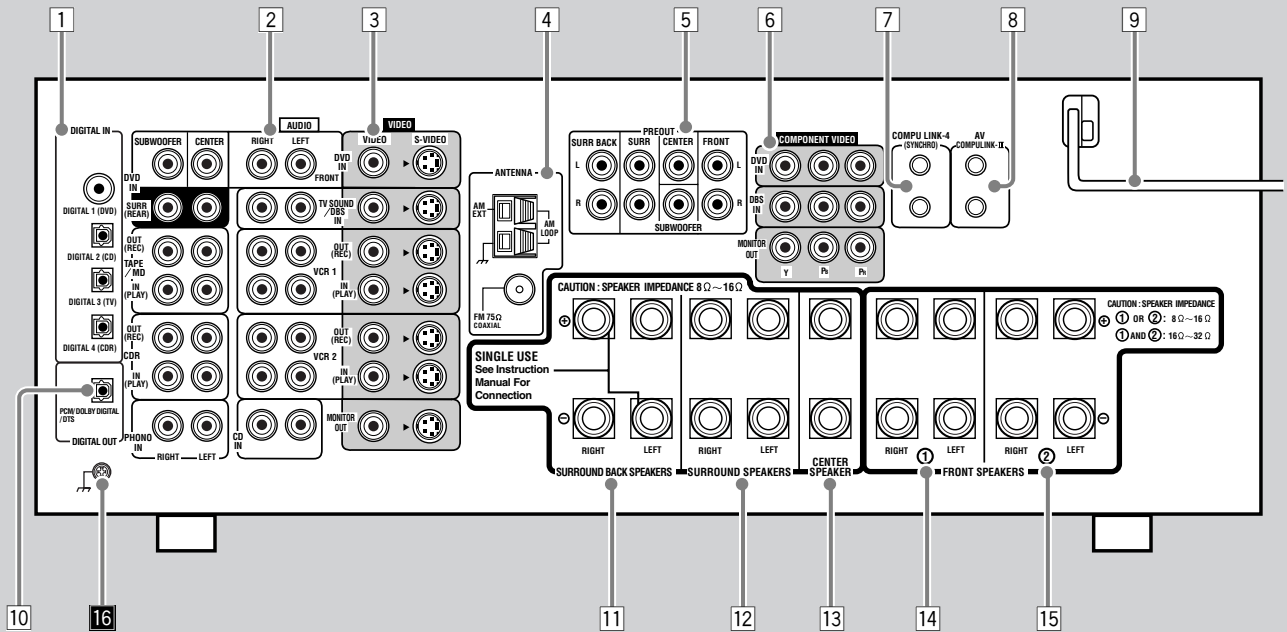

RX-7030VBK / RX-7032VSL

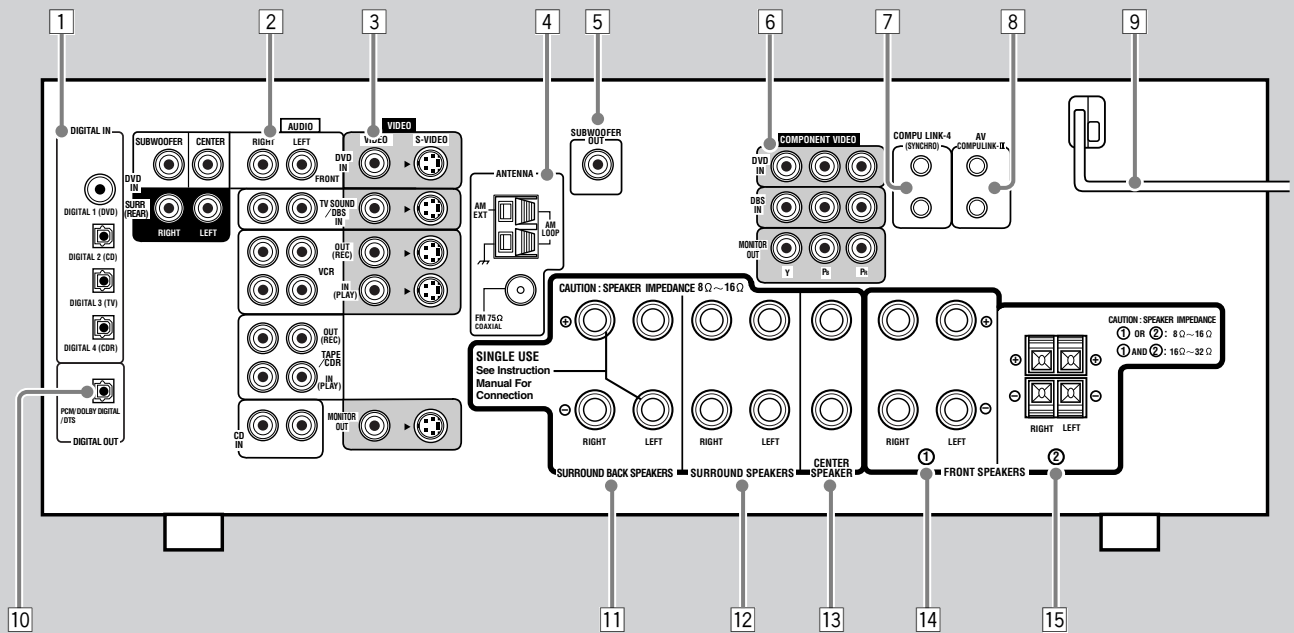

Rear Panel

RX-8030VBK

- 1 DIGITAL IN terminals (16)
 - Coaxial: DIGITAL 1 (DVD)
 - Optical: DIGITAL 2 (CD), DIGITAL 3 (TV), DIGITAL 4 (CDR)
- 2 AUDIO input/output jacks (11 – 15)
 - Input: DVD IN—FRONT, CENTER, SUBWOOFER, SURR (REAR), TV SOUND/DBS IN, VCR 1 IN (PLAY), VCR 2 IN (PLAY), CD IN, TAPE/MD IN (PLAY), CDR IN (PLAY), PHONO IN
 - Output: VCR 1 OUT (REC), VCR 2 OUT (REC), TAPE/MD OUT (REC), CDR OUT (REC)
- 3 S-VIDEO and composite VIDEO input/output jacks (14, 15)
 - Input: DVD IN, TV SOUND/DBS IN, VCR1 IN (PLAY), VCR 2 IN (PLAY)
 - Output: VCR 1 OUT (REC), VCR 2 OUT (REC), MONITOR OUT
- 4 FM/AM ANTENNA terminals (8)
- 5 PREOUT jacks (10, 11)
 - FRONT, CENTER, SUBWOOFER, SURR, SURR BACK
- 6 COMPONENT VIDEO input/output jacks (14, 15)
 - Input: DVD IN, DBS IN
 - Output: MONITOR OUT
- 7 COMPU LINK-4 (SYNCHRO) terminals (41)
- 8 AV COMPULINK-III terminals (42)
- 9 AC power cord (16)
- 10 DIGITAL OUT terminal (16)
- 11 SURROUND BACK SPEAKERS terminals (10)
- 12 SURROUND SPEAKERS terminals (10)
- 13 CENTER SPEAKER terminals (10)
- 14 FRONT SPEAKERS ① terminals (10)
- 15 FRONT SPEAKERS ② terminals (10)
- 16 Earth (ground) terminal (11)

RX-7030VBK/RX-7032VSL

- 1 DIGITAL IN terminals (16)
 - Coaxial: DIGITAL 1 (DVD)
 - Optical: DIGITAL 2 (CD), DIGITAL 3 (TV), DIGITAL 4 (CDR)
- 2 AUDIO input/output jacks (12 – 15)
 - Input: DVD IN—FRONT, CENTER, SUBWOOFER, SURR (REAR), TV SOUND/DBS IN, VCR IN (PLAY), TAPE/CDR IN (PLAY), CD IN
 - Output: VCR OUT (REC), TAPE/CDR OUT (REC)
- 3 S-VIDEO and composite VIDEO input/output jacks (14, 15)
 - Input: DVD IN, TV SOUND/DBS IN, VCR IN (PLAY)
 - Output: VCR OUT (REC), MONITOR OUT
- 4 FM/AM ANTENNA terminals (8)
- 5 SUBWOOFER OUT jack (10)
- 6 COMPONENT VIDEO input/output jacks (14, 15)
 - Input: DVD IN, DBS IN
 - Output: MONITOR OUT
- 7 COMPU LINK-4 (SYNCHRO) terminals (41)
- 8 AV COMPULINK-III terminals (42)
- 9 AC power cord (16)
- 10 DIGITAL OUT terminal (16)
- 11 SURROUND BACK SPEAKERS terminals (10)
- 12 SURROUND SPEAKERS terminals (10)
- 13 CENTER SPEAKER terminals (10)
- 14 FRONT SPEAKERS ① terminals (10)
- 15 FRONT SPEAKERS ② terminals (10)

Differences between RX-8030VBK and RX-7030VBK/RX-7032VSL

○: Supplied ×: Not supplied

| | Video jacks (input/output) | PREOUT jacks | CC Converter | Selectable source |
|----------------------------------|---|--------------|--------------|--|
| RX-8030VBK | Composite video (4/3) S-video (4/3) Component video (2/1) | ○ | ○ | DVD MULTI, DVD, VCR 1, VCR 2, VIDEO, TV SOUND/DBS, PHONO, CD, CDR, TAPE/MD, FM, AM |
| RX-7030VBK RX-7032VSL | Composite video (3/2) S-video (3/2) Component video (2/1) | × | × | DVD MULTI, DVD, VCR, TV SOUND/DBS, CD, TAPE/CDR, FM, AM |

| Remote Control | Display Window | Color |
|--------------------|----------------|--------|
| RM-SRX8030J | ○ | Black |
| RM-SRX7030J | × | Black |
| RM-SRX7032U | × | Silver |

Getting Started

This section explains how to connect audio/video components and speakers to the receiver, and how to connect the power supply.

Before Installation

General Precautions

- Be sure your hands are dry.
- Turn the power off to all components.
- Read the manuals supplied with the components you are going to connect.

Locations

- Install the receiver in a location that is level and protected from moisture.
- The temperature around the receiver must be between -5°C and 35°C (23°F and 95°F).
- Make sure there is good ventilation around the receiver. Poor ventilation could cause overheating and damage the receiver.

Handling the receiver

- Do not insert any metal object into the receiver.
- Do not disassemble the receiver or remove screws, covers, or cabinet.
- Do not expose the receiver to rain or moisture.

Checking the Supplied Accessories

Check to be sure you have all of the following items, which are supplied with the receiver. The number in the parentheses indicates quantity of the pieces supplied.

- Remote Control (1)
- Batteries (2)
- AM Loop Antenna (1)
- FM Antenna (1)

If anything is missing, contact your dealer immediately.

Putting Batteries in the Remote Control

Before using the remote control, insert the two supplied batteries first.

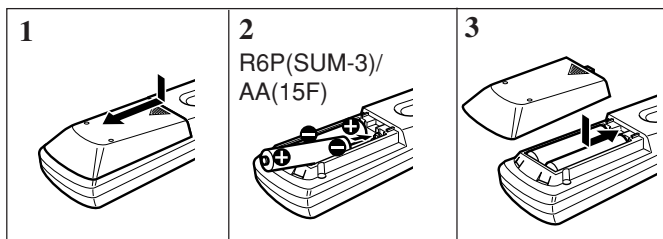

1. Press and slide the battery cover on the back of the remote control.

2. Insert the batteries.

- Make sure to match the polarity: (+) to (+) and (-) to (-).

3. Replace the cover.

If the remote control cannot transmit signals or operate the receiver correctly, replace the batteries. Use two R6P(SUM-3)/AA(15F) type dry-cell batteries.

Notes:

- Supplied batteries are for the initial setup. Replace for continued use.
- After replacing the batteries, set the manufacturers' codes again (see pages from 47 to 49).

CAUTION:

Follow these precautions to avoid leaking or cracking cells:

- Place batteries in the remote control so they match the polarity: (+) to (+) and (-) to (-).
- Use the correct type of batteries. Batteries that look similar may differ in voltage.
- Always replace both batteries at the same time.
- Do not expose batteries to heat or flame.

Connecting the FM and AM Antennas

FM Antenna Connections

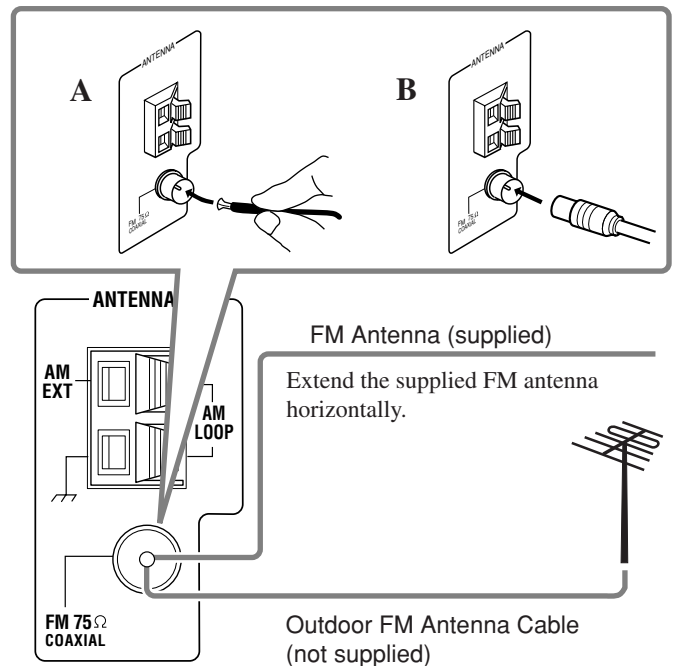

A. Using the Supplied FM Antenna

The FM antenna provided can be connected to the FM 75 Ω COAXIAL terminal as temporary measure.

B. Using the Standard Type Connector (Not Supplied)

A standard type connector should be connected to the FM 75 Ω COAXIAL terminal.

Note:

If reception is poor, connect the outdoor FM antenna (not supplied). Before attaching a 75 Ω coaxial cable with a connector (the kind with a round wire going to an outdoor antenna), disconnect the supplied FM antenna.

AM Antenna Connections

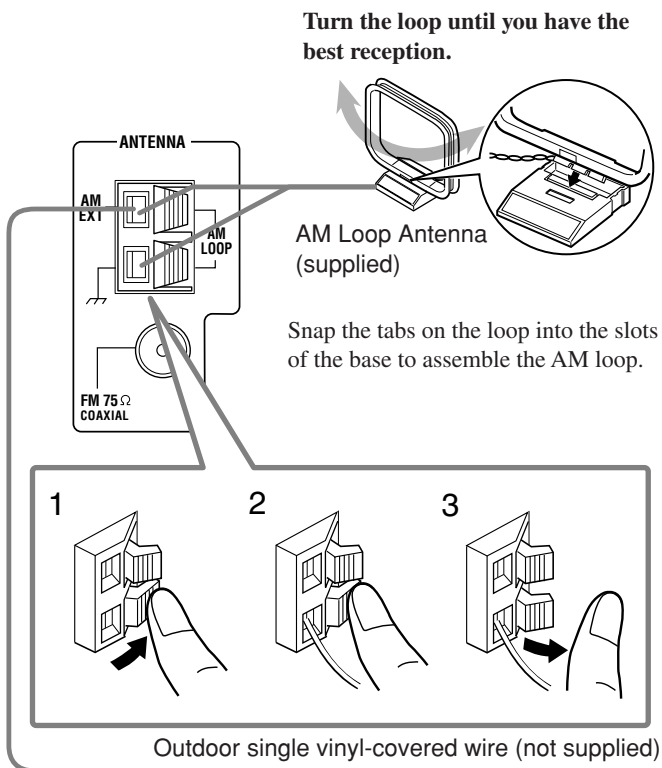

Notes:

- If the AM loop antenna wire is covered with vinyl, remove the vinyl by twisting it as illustrated.
- Make sure the antenna conductors do not touch any other terminals, connecting cords and power cord. This could cause poor reception.
- If reception is poor, connect an outdoor single vinyl-covered wire (not supplied) to the AM EXT terminal. (Keep the AM loop antenna connected.)

Connecting the Speakers

You can connect the following speakers:

- Two pairs of front speakers to produce normal stereo sound.
- One pair of surround speakers to enjoy the surround effect.
- One surround back speaker or one pair of surround back speakers to enjoy to produce more effective surround effect.
- One center speaker to emphasize human voices.
- One subwoofer to enhance the bass.

CAUTION:

Use only the speakers of the SPEAKER IMPEDANCE indicated by the speaker terminals.

- **When connecting to both of the FRONT SPEAKERS ① and ② terminals**, use speakers with an impedance of 16 Ω to 32 Ω .
- **When connecting to either the FRONT SPEAKERS ① or ② terminals**, use speakers with an impedance of 8 Ω to 16 Ω .

Basic connecting procedure

1 Twist and remove the insulation at the end of each speaker signal cable (not supplied).



2 Open the speaker terminal.

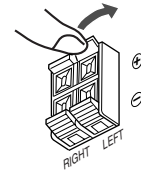
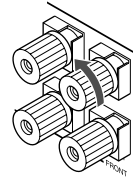

RX-7030VBK/RX-7032VSL
(For FRONT SPEAKERS 2 terminals)

3 Insert the speaker signal cable.

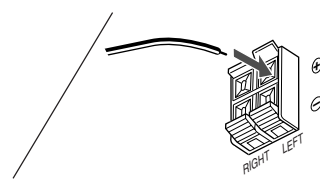
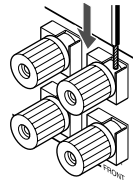

4 Close the speaker terminal.

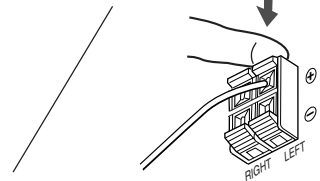
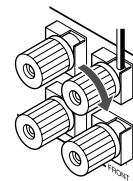

For each speaker (except for a subwoofer), connect the (+) and (-) terminals on the rear panel to the (+) and (-) terminals marked on the speakers.

Speaker layout

Ideal speaker layout varies depending on the conditions of your listening room. The diagram below is a recommended typical example.

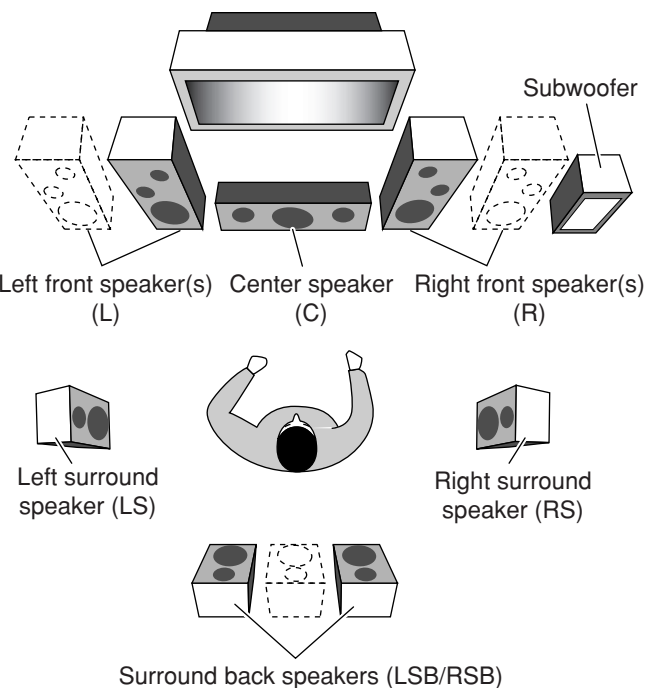

- Rear terminals of RX-8030VBK are used for explanation.

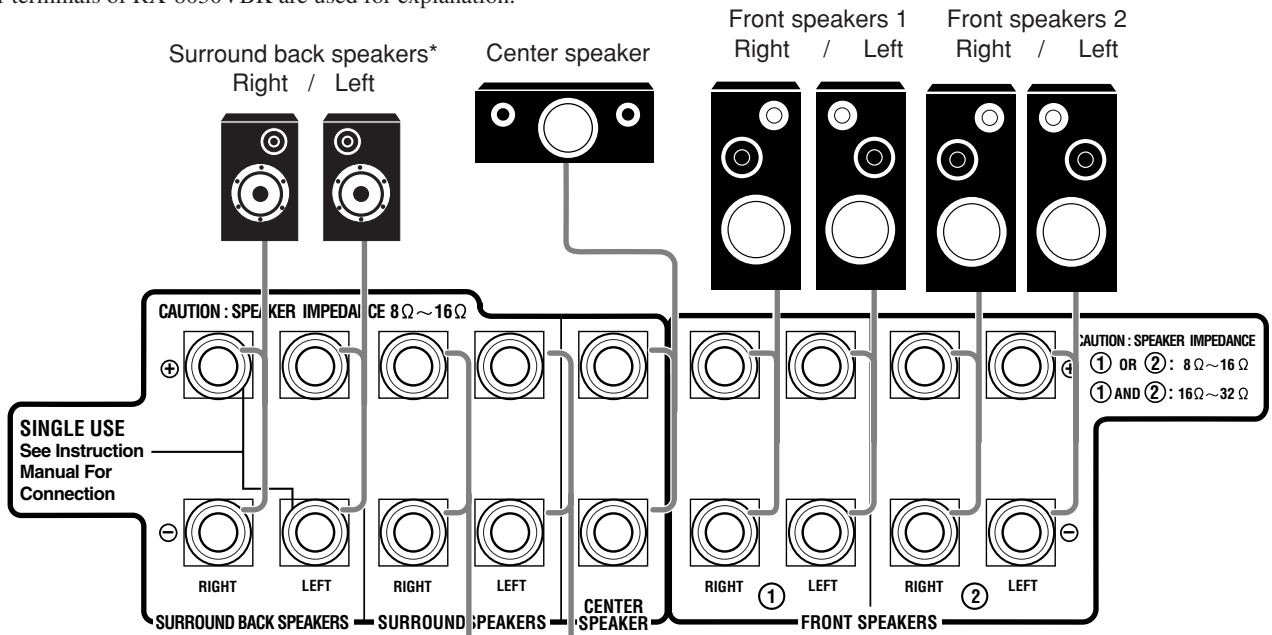

* When using only one surround back speaker, connect the ⊕ cord to the RIGHT ⊕ terminal and the ⊖ cord to the LEFT ⊖ terminal.

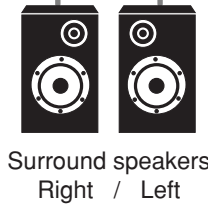
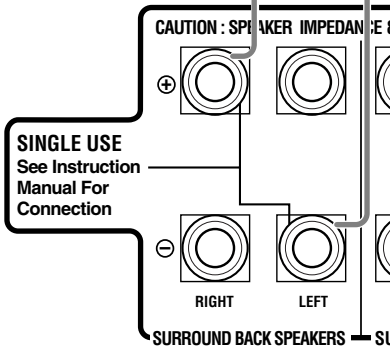

IMPORTANT:

After connecting the speakers, set the speaker installation information properly. You can use Quick Speaker Setup for easy speaker installation information setting (see page 25).

- To obtain the best possible Surround/DSP effect, see “Setting the Speakers” on page 27.

Connecting the subwoofer speaker

You can enhance the bass by connecting a subwoofer. Connect the input jack of a powered subwoofer to the rear panel, using a cable with RCA pin plugs (not supplied).

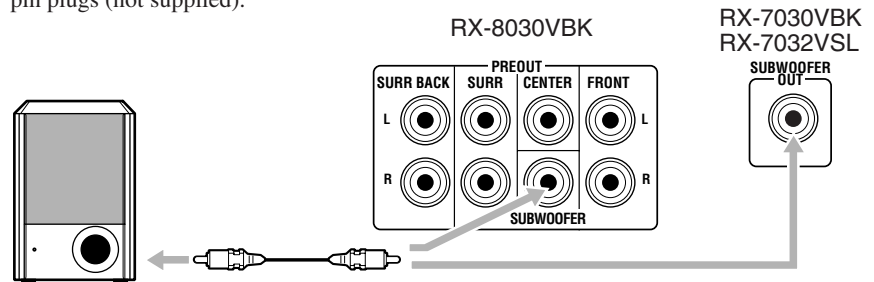

Placing speakers

Front speakers and center speaker

- Place these speakers (position of the mid-range speaker units) at the same height from the floor.
- Point these speakers aiming at the listener’s ears.

Surround and surround back speakers

- Place these speakers at a position which is 1 meter higher than the listener’s ears.
- Point these speakers down aiming at the listener’s ears.

Subwoofer

- You can place it wherever you like since bass sound is non-directional. Normally place it in front of you.

Note:

Ideal speaker layout requires that all speakers be placed at the same distance from the listener. However, since in some places it may be difficult to fulfil this requirement, this unit can adjust the delay time so that the sounds through all the speakers reach the listener with the same timing. (See page 28.)

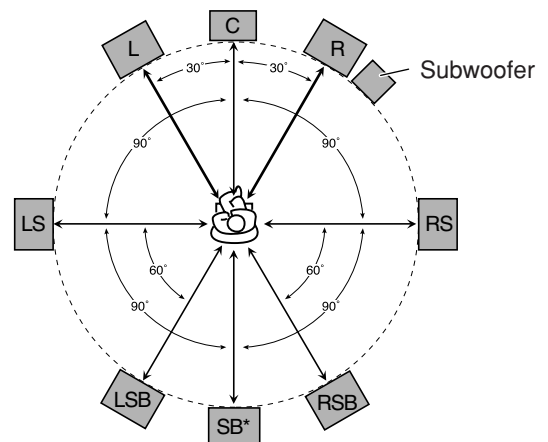

* When one surround back speaker is connected.

Enhancing your audio system —Only for RX-8030VBK



You can use this receiver as the pre-amplifier (control amplifier) when you connect power amplifiers to the PREOUT jacks on the rear using cables with RCA pin plugs (not supplied).

- Connect the white plug to the audio left jack, and the red plug to the audio right jack.

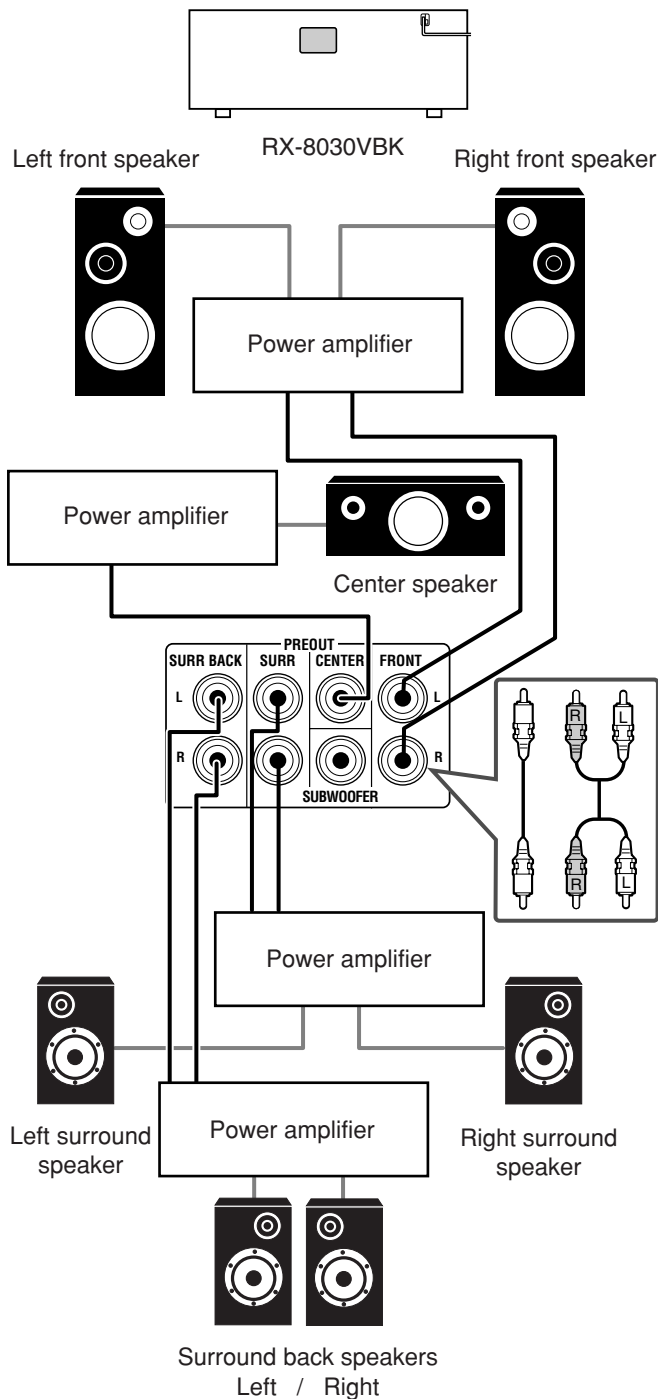

Note:

If you connect one surround back speaker, connect the surround back speaker to the left surround back PREOUT jack (SURRE BACK L).

Connecting Audio/Video Components

When connecting individual components, refer also to the manuals supplied with them.

Analog Connections

If your audio components have digital audio output terminal, connecting them using the digital cords explained in “Digital Connections” (see page 16) will give you better sound quality.

Audio component connections

Use the cables with RCA pin plugs (not supplied).

- Connect the white plug to the audio left jack, and the red plug to the audio right jack.

If your audio components have a COMPU LINK jack

See also page 41 for detailed information about the connection and the COMPU LINK remote control system.

CAUTION:

If you connect a sound-enhancing device such as a graphic equalizer between the source components and this receiver, the sound output through this receiver may be distorted.

Turntable



To listen to the sound after connection, press PHONO.

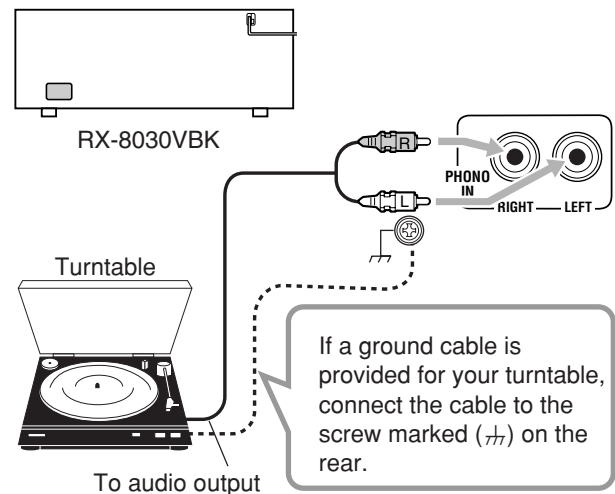

Note:

This connection is for the turntable with an MM (moving-magnet) type cartridge. Any turntables incorporating a small-output cartridge such as an MC (moving-coil) type must be connected to this receiver through a commercial head amplifier or step-up transformer. Direct connection may result in insufficient volume.

CD player

To listen to the sound after connection, press CD.

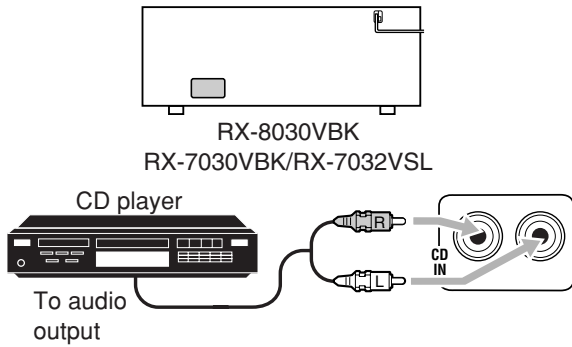

Cassette deck

To listen to the sound after connection, press TAPE/MD (for RX-8030VBK) or TAPE/CDR (for RX-7030VBK/RX-7032VSL).

For RX-8030VBK

You can connect either a cassette deck or an MD recorder to the TAPE/MD jacks. When connecting an MD recorder, see page 13.

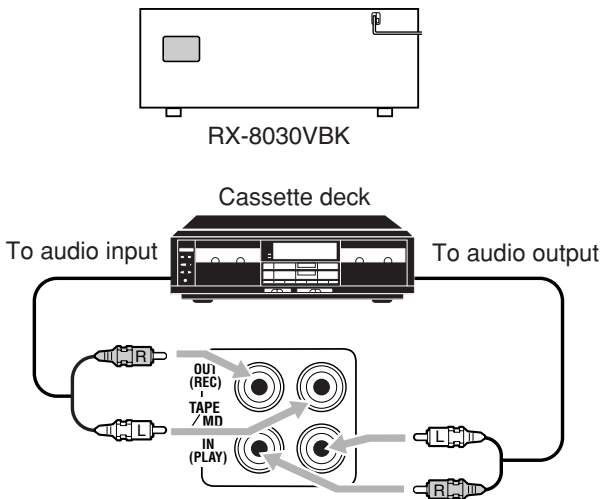

For RX-7030VBK/RX-7032VSL

You can connect either a cassette deck or a CD recorder to the TAPE/CDR jacks. When connecting an CD recorder to the TAPE/CDR jacks, see the right column.

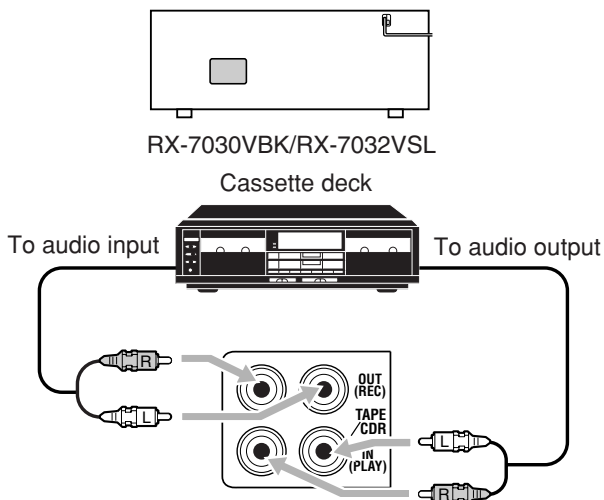

CD recorder

To listen to the sound after connection, press CDR (for RX-8030VBK) or TAPE/CDR (for RX-7030VBK/RX-7032VSL).

For RX-8030VBK

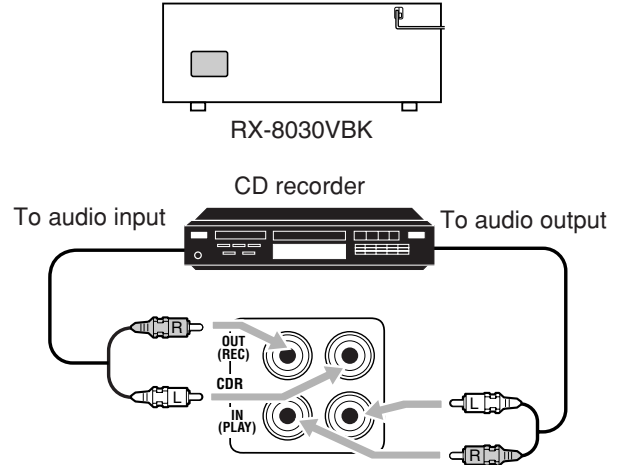

For RX-7030VBK/RX-7032VSL

You can connect either a CD recorder or a cassette deck to the TAPE/CDR jacks. When connecting a cassette deck to the TAPE/CDR jacks, see the left column.

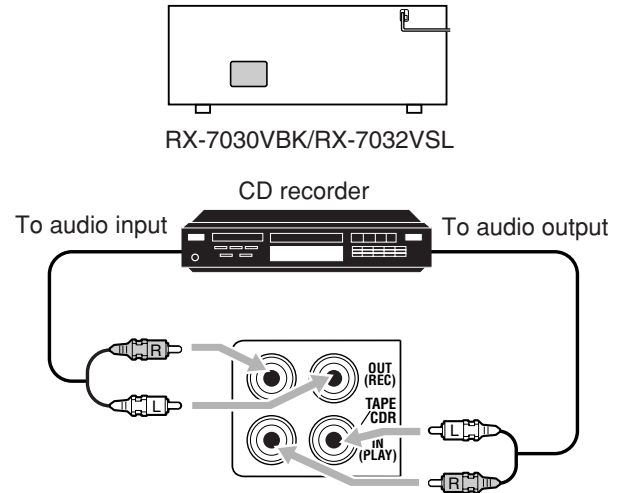

Note:

For RX-7030VBK/RX-7032VSL: When connecting a CD recorder to the TAPE/CDR jacks, change the source name to "CDR," which will be shown on the display when it is selected as the source. See page 21 for details.

MD recorder

To listen to the sound after connection, press TAPE/MD (for RX-8030VBK) or TAPE/CDR (for RX-7030VBK/RX-7032VSL).

For RX-8030VBK

You can connect either an MD recorder or a cassette deck to the TAPE/MD jacks. When connecting a cassette deck, see page 12.

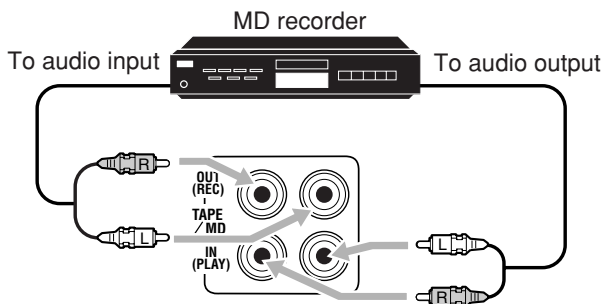
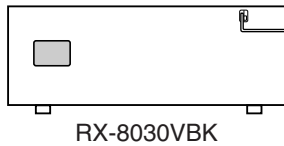

Note:

When connecting an MD recorder to the TAPE/MD jacks, change the source name to "MD," which will be shown on the display when it is selected as the source. See page 21 for details.

For RX-7030VBK/RX-7032VSL

You can connect an MD recorder to the TAPE/CDR jacks if they are not used for connecting another component such as a cassette deck or CD recorder. When connecting an MD recorder to the TAPE/CDR jacks, see page 12.

- Though your MD recorder is one of JVC products with the COMPU LINK remote control system, you cannot use the COMPU LINK remote control system to operate the connected MD recorder.

Video component connections

Use the cables with RCA pin plugs (not supplied). Connect the white plug to the audio left jack, the red plug to the audio right jack, and the yellow plug to the video jack.

- If your video components have S-video (Y/C-separation) and/or component video (Y, P_B, P_R) terminals, connect them using an S-video cable (not supplied) and/or component video cable (not supplied). By using these jacks, you can get better picture quality in the order—Component video > S-video > Composite video.

If your video components have an AV COMPULINK jack

See also page 42 for detailed information about the connection and the AV COMPU LINK remote control system.

IMPORTANT:

This receiver is equipped with the following video jacks—composite video, S-video and component video jacks. You can use any of the three to connect a video component.

However, **the video signals from one type of these input jacks are transmitted only through the video output jacks of the same type.**

Therefore, if a recording video component and a playing video component are connected to the receiver through the video jacks of different type, you cannot record the picture. In addition, if the TV and a playing video component are connected to the receiver through the video jacks of different type, you cannot view the playback picture on the TV.

Video camera



To listen to the sound after connection, press VIDEO.

The VIDEO input jacks on the front panel (inside the front door) are convenient when connecting and disconnecting the component frequently.

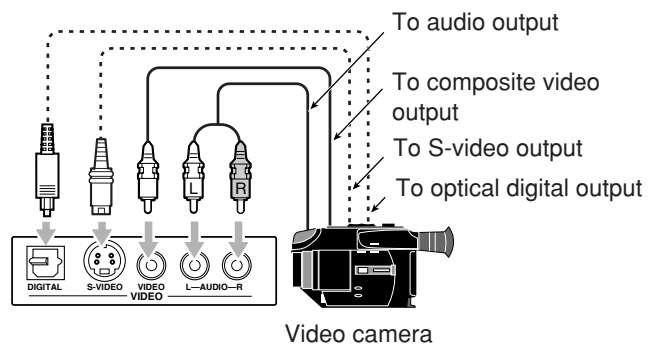
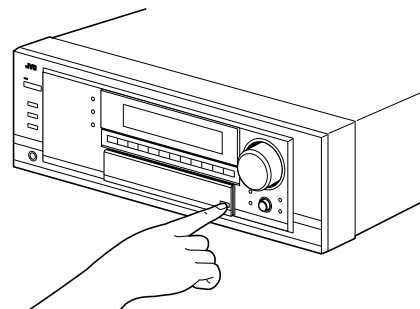

When using the digital input terminal

Select the digital input mode correctly.

For details, see "Selecting the Analog or Digital Input Mode" on page 19.

VCR(s)

To listen to the sound after connection, press VCR 1 or VCR 2 (for RX-8030VBK) or VCR (for RX-7030VBK/RX-7032VSL).

For RX-8030VBK

You can connect two VCRs—one to the VCR 1 jacks and the other to the VCR 2 jacks.

- If your VCR has an AV COMPU LINK jack, connect it to the VCR 1 jack so that you can use the AV COMPU LINK remote control system.

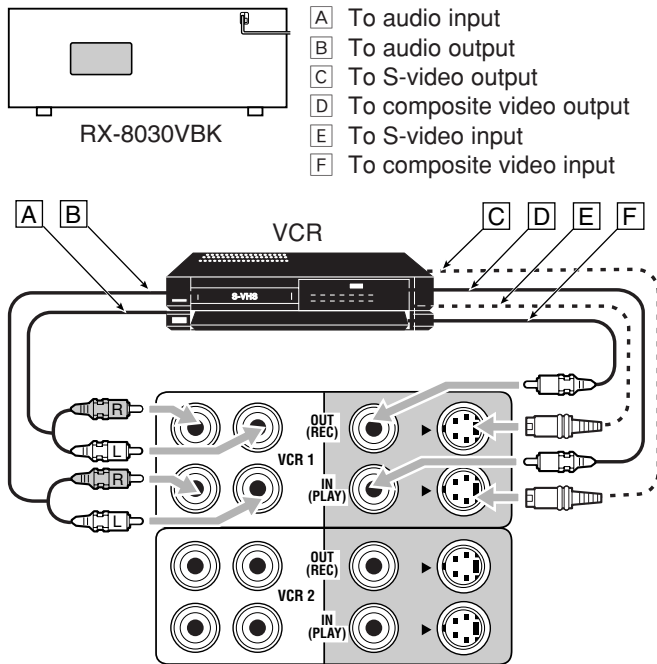

For RX-7030VBK/RX-7032VSL

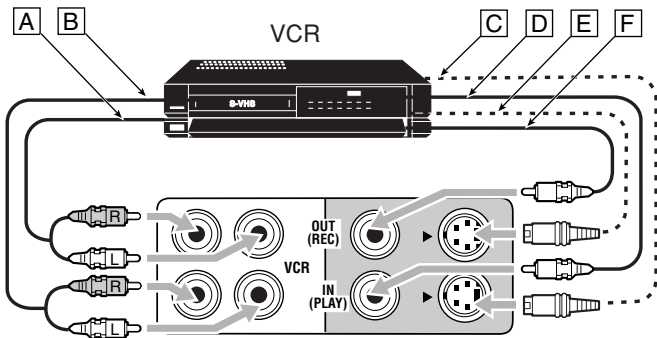
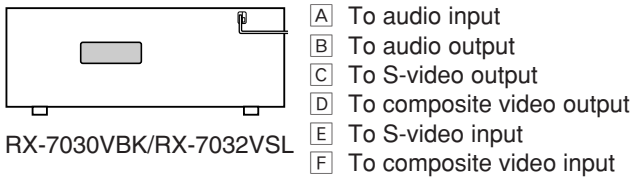

TV and/or DBS tuner

To listen to the sound after connection, press TV SOUND/DBS (or TV/DBS on the remote control).

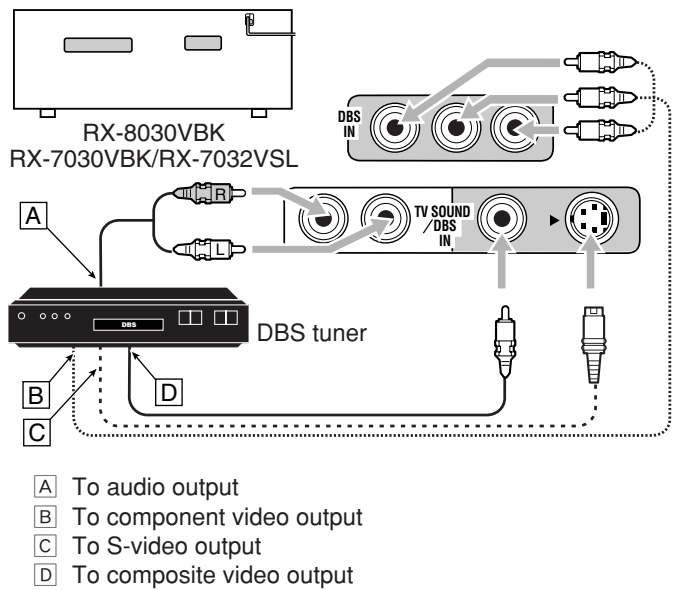
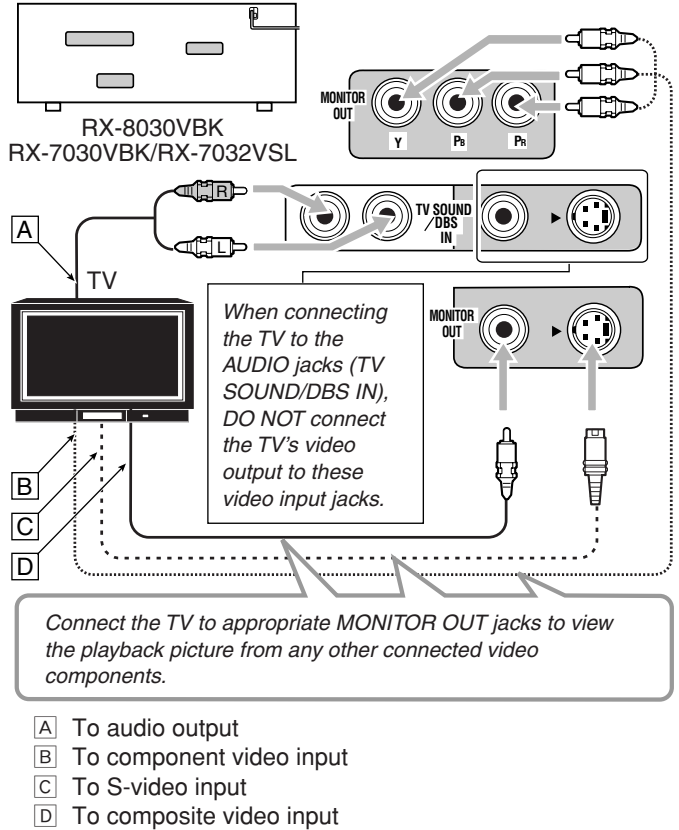

Notes:

- When connecting a DBS tuner to the TV SOUND/DBS IN jacks, change the source name to "DBS," which will be shown on the display when selected as the source. Otherwise you cannot view any picture from DBS tuner. See page 21 for details.
- When connecting a DBS tuner to either one of the component input jacks, make the component video input setting correctly for AV COMPU LINK. See page 30 for details.

DVD player

- When you connect a DVD player with stereo output jacks:

To listen to the sound after connection, press DVD.

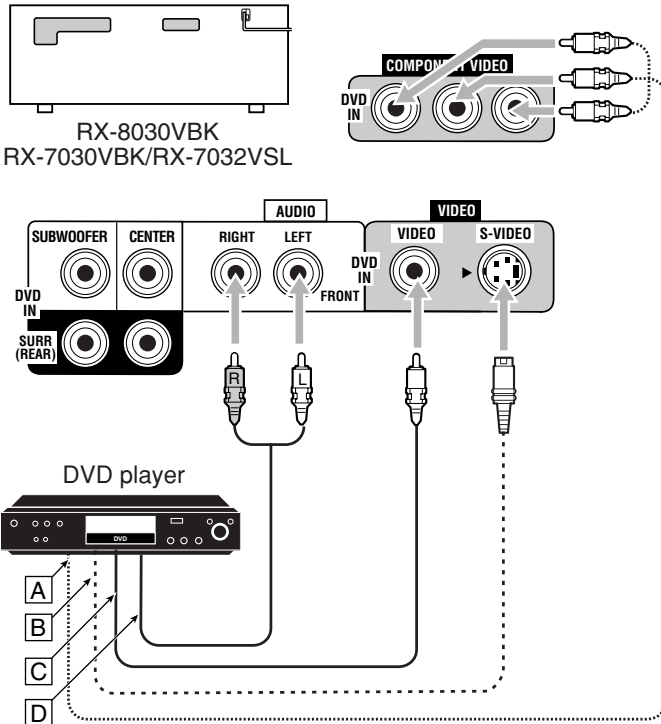

- A To component video output
- B To S-video output
- C To composite video output
- D To left/right front channel audio output (or to audio-mixed output if necessary)

Note:

When connecting a DVD player to the component video input jacks, make the component video input setting correctly for AV COMPU LINK. See page 30 for details.

- When you connect a DVD player with its analog discrete output (5.1-channel reproduction) jacks:

To listen to the sound after connection, press DVD MULTI.

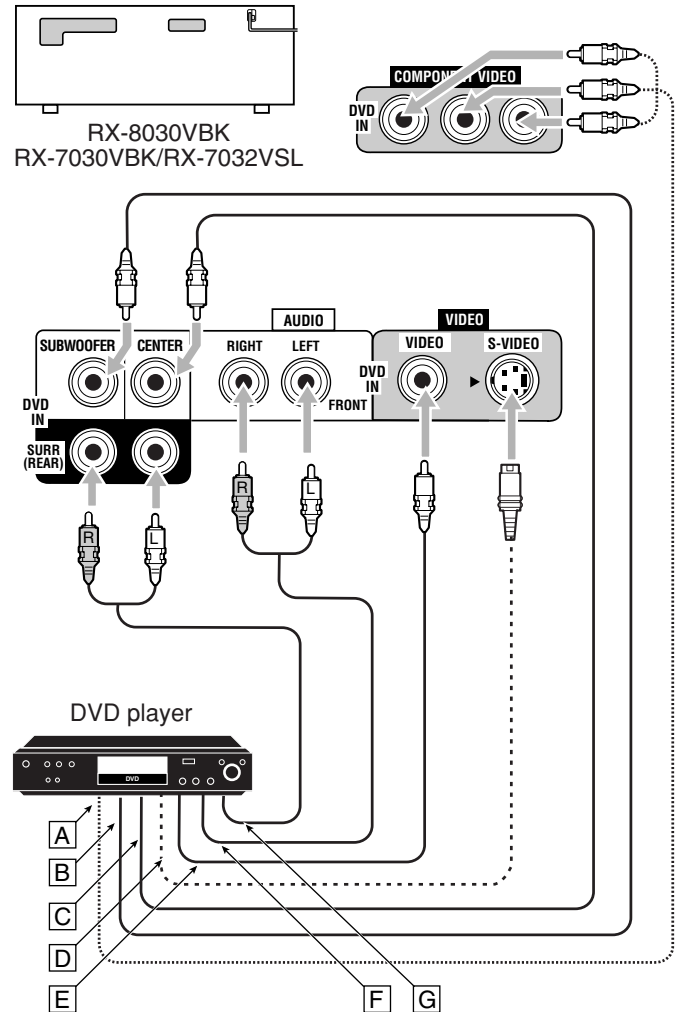

- A To component video output
- B To subwoofer output
- C To center channel audio output
- D To S-video output
- E To composite video output
- F To left/right front channel audio output
- G To left/right surround channel audio output

Note:

When connecting a DVD player to the component video input jacks, make the component video input setting correctly for AV COMPU LINK. See page 30 for details.

Digital Connections

This receiver is equipped with four DIGITAL IN terminals—one digital coaxial terminal and three digital optical terminals—and one DIGITAL OUT (optical) terminal on the rear.

- For **RX-8030VBK**: Another digital optical input terminal is located on the front panel (see page 13).

IMPORTANT:

- When connecting a DVD player, digital TV broadcast tuner or DBS tuner using the digital terminals, you also need to connect it to the video jacks on the rear. Without connecting it to the video jacks, you can view no playback picture.
- After connecting the components using the DIGITAL IN terminals, set the following correctly if necessary.
 - Set the digital input (DIGITAL IN) terminal setting correctly. For details, see “Setting the Digital Input Terminals” on page 29.
 - Select the digital input mode correctly. For details, see “Selecting the Analog or Digital Input Mode” on page 19.

Digital input terminals

You can connect any digital components having coaxial or optical digital output terminal.

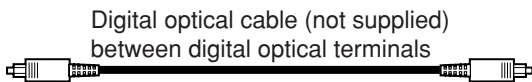
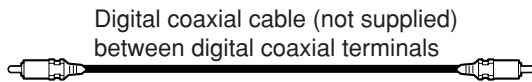

When the component has a digital coaxial output terminal, connect it to the DIGITAL 1 (DVD) terminal, using a digital coaxial cable (not supplied).

When the component has a digital optical output terminal, connect it to the DIGITAL 2 (CD), DIGITAL 3 (TV) or DIGITAL 4 (CDR) terminal, using a digital optical cable (not supplied).

Before connecting a digital optical cable, unplug the protective plug.

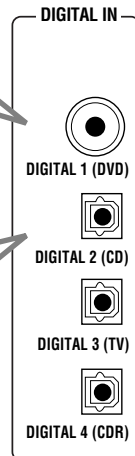
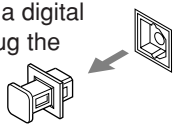

Digital output terminal

You can connect any digital components which have an optical digital input terminal.

Digital optical cable (not supplied)
between digital optical terminals



When the digital recording equipment such as an MD recorder and CD recorder has a digital optical input terminal, connecting it to the DIGITAL OUT terminal enables you to perform digital-to-digital recording.

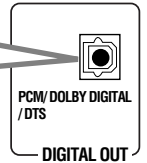

Note:

The digital signal format transmitted through the DIGITAL OUT terminal is the same as that of the input signal. This means that when the DTS Digital Surround signals are input, the DTS Digital Surround signals are transmitted.

Connecting the Power Cord

Before plugging the receiver into an AC outlet, make sure that all connections have been made.

Plug the power cord into an AC outlet.

Keep the power cord away from the connecting cables and the antenna. The power cord may cause noise or screen interference.

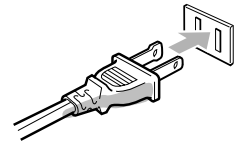

Note:

The preset settings such as preset channels and sound adjustment may be erased in a few days in the following cases:

- When you unplug the power cord.
- When a power failure occurs.

CAUTIONS:

- Do not touch the power cord with wet hands.
- Do not pull on the power cord to unplug the cord. When unplugging the cord, always grasp the plug so as not to damage the cord.

Notes:

- When shipped from the factory, the DIGITAL IN terminals have been set for use with the following components:
 - DIGITAL 1 (coaxial): For DVD player
 - DIGITAL 2 (optical): For CD player
 - DIGITAL 3 (optical): For digital TV broadcast tuner
 - DIGITAL 4 (optical): For CD recorder
- When you want to operate the CD player or CD recorder, (or MD recorder: only for RX-8030VBK) using the COMPU LINK remote control system, connect the target component also as described in “Analog Connections” (see pages 12 and 13).
- When you want to operate a DVD player using the AV COMPU LINK remote control system (see page 42), connect the DVD player also as described in “Analog Connections” (see page 15).

Basic Operations

The following operations are commonly used when you play any sound sources.

Operations hereafter will be explained using the buttons on the front panel.

You can also use the buttons on the remote control for the same functions if they have the same and similar names/marks.

Daily Operational Procedure

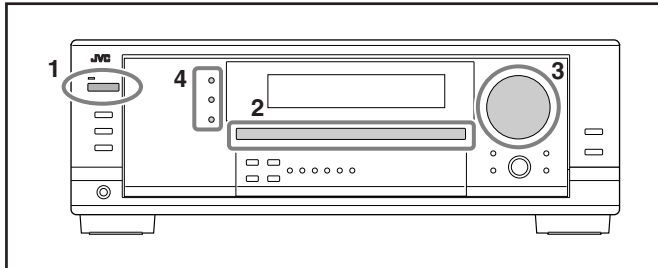

- 1 Turn on the power.**
 - See “Turning On the Power” below.
- 2 Select the source.**
 - See “Selecting the Source to Play” to the right.
- 3 Adjust the volume.**
 - See “Adjusting the Volume” on page 18.
- 4 Select the surround or DSP modes.**
 - See “Activating the Surround Modes” (page 37) and “Activating the DSP Modes” (page 39).

Turning On the Power

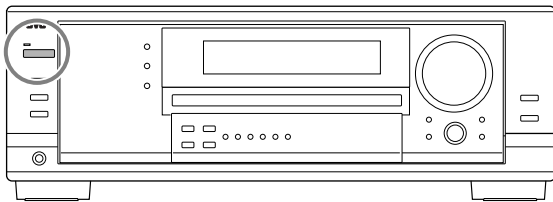

Press **STANDBY/ON** (or **AUDIO** on the remote control).

The **STANDBY** lamp goes off. The name of the current source and Surround/DSP mode appear on the display.

Current source name and Surround/DSP mode appear

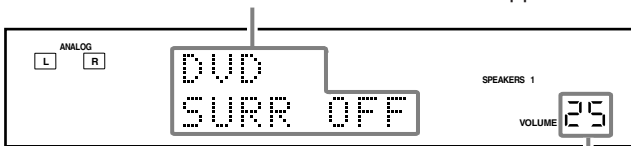

Current volume level appears.

To turn off the power (into standby mode), press **STANDBY/ON** (or **AUDIO** on the remote control) again.

The **STANDBY** lamp lights up.

Note:

A small amount of power is consumed in standby mode. To turn off the power completely, unplug the AC power cord.

Selecting the Source to Play

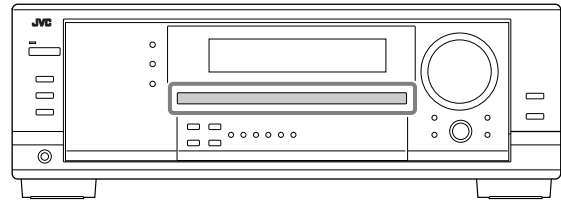

Press one of the source selection buttons.

- The selected source name and the previously selected Surround/DSP mode also appear on the display.

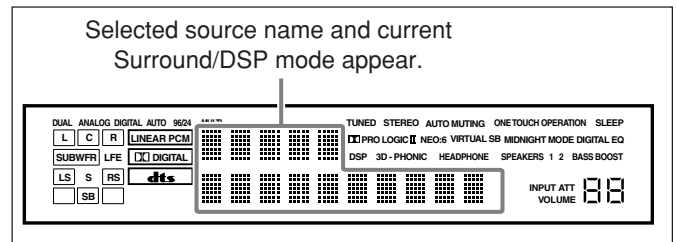

For **RX-8030VBK**

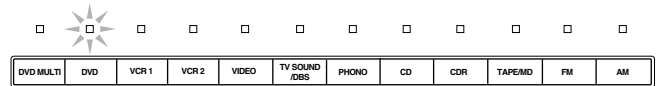

On the unit

- The lamp on the selected source lights up (ex. when DVD is selected as the source).

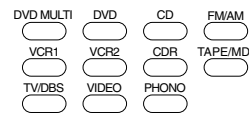

On the remote

For **RX-7030VBK/RX-7032VSL**

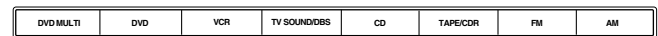

On the unit



On the remote

Notes:

- For **RX-8030VBK**: When connecting an MD recorder (to the TAPE/MD jack) and a DBS tuner (to the TV SOUND/DBS jacks), change the source names shown on the display. For details, see page 21.
- For **RX-7030VBK/RX-7032VSL**: When connecting an CD recorder (to the TAPE/CDR jacks) and a DBS tuner (to the TV SOUND/DBS jacks), change the source names shown on the display. For details, see page 21.

Speaker and signal indicators on the display

By checking the following indicators, you can easily confirm which speakers you are activating and which signals are coming into this receiver.

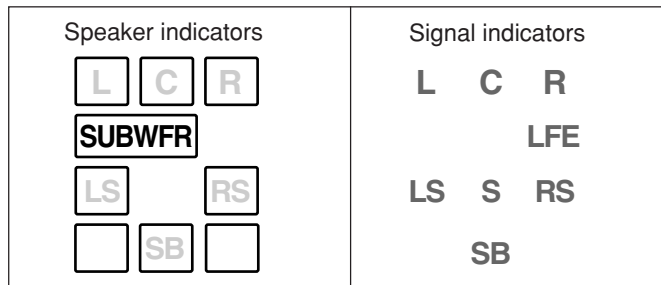

What speaker indicators light depends on the speaker setting (for details, see "Setting the Speakers" on page 27).

- The frames of "L," "C," "R," "LS," "RS," and "SB" light up, when the corresponding speakers are set to "LARGE" or "SMALL" and when the speaker is required for the Surround/DSP mode currently selected.
- When "SUB WOOFER" is set to "YES," **SUBWFR** lights up (see page 27).
- All three frames on the row of "SB" are not used at the same time. When "SBACK OUT" is set to "2SPK," the left and the right ones are used. When it is set to "1SPK," the middle one is used (see page 27).

The signal indicators light up to show the incoming signals.

- L: • **When digital input is selected:** Lights up when the left channel signal comes in.
 • **When analog input is selected:** Always lights up.
- R: • **When digital input is selected:** Lights up when the right channel signal comes in.
 • **When analog input is selected:** Always lights up.
- C: Lights up when the center channel signal comes in.
- LFE: Lights up when the LFE channel signal comes in.
- LS: Lights up when the left surround channel signal comes in.
- RS: Lights up when the right surround channel signal comes in.
- S: Lights up when the monaural surround channel signal comes in.
- SB: Lights up when the surround back channel signal comes in.

Note:

When "DVD MULTI" is selected as the source, "L," "C," "R," "LFE," "LS," and "RS" light up.

How to understand the speaker and signal indicator illumination

| | |
|------------|--|
| L C R | Ex. No sound comes out of the center speaker and surround back speakers though center channel and surround back channel signals are coming into this receiver. |
| SUBWFR LFE | |
| LS RS | |
| SB | |

Selecting different sources for picture and sound

While watching pictures from a video source, you can listen to sound of an audio source.

- Once you have selected a video source, pictures of the selected source are sent to the TV until you select another video source.

Press one of the audio source selection buttons while viewing the picture from a video component such as the VCR or DVD player, etc.

For RX-8030VBK



On the unit

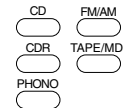

On the remote

For RX-7030VBK/RX-7032VSL

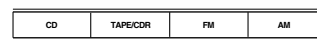

On the unit

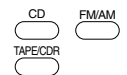

On the remote

Note:

When you see the picture through the COMPONENT VIDEO jacks, you cannot use this function.

Adjusting the Volume

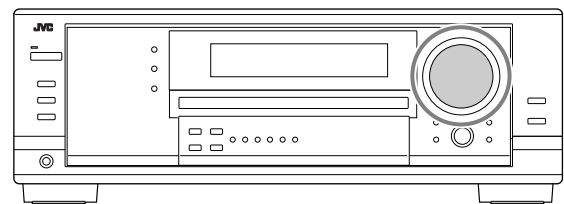

On the front panel:

To increase the volume, turn MASTER VOLUME clockwise.
To decrease the volume, turn it counterclockwise.

From the remote control:

To increase the volume, press VOLUME +.
To decrease the volume, press VOLUME -.

CAUTION:

Always set the volume to the minimum before starting any sources. If the volume is set at its high level, the sudden blast of sound energy can permanently damage your hearing and/or ruin your speakers.

Notes:

- The volume level can be adjusted within the range of "0" (minimum) to "70" (maximum).
- If you set One Touch Operation to "ON" (see page 30), you do not have to adjust the volume level each time you change the source. It is automatically set to the stored level.

Selecting the Front Speakers



When you have connected two pairs of the front speakers, you can select which to use.

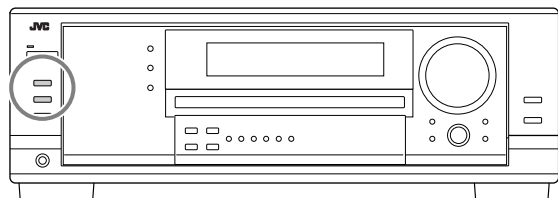

To use the speakers connected to the FRONT SPEAKERS ① terminals, press SPEAKERS ON/OFF 1 so that the SPEAKERS 1 indicator lights up on the display. Make sure that the SPEAKERS 2 indicator is not lit on the display.

To use the speakers connected to the FRONT SPEAKERS ② terminals, press SPEAKERS ON/OFF 2 so that SPEAKERS 2 indicator lights up on the display. Make sure that the SPEAKERS 1 indicator is not lit on the display.

To use both sets of the speakers, press SPEAKERS ON/OFF 1 and SPEAKERS ON/OFF 2 so that the SPEAKERS 1/2 indicators light up on the display.

To use neither sets of the speakers, press SPEAKERS ON/OFF 1 and SPEAKERS ON/OFF 2 so that the SPEAKERS 1/2 indicators go off from the display.

The HEADPHONE indicator lights up and “HEADPHONE” appears on the display.

- Activating the speakers turns on the Surround and DSP modes previously selected.

Listening with headphones only:

Deactivate both sets of the front speakers, and connect headphones to the PHONES jack.

You can enjoy the sound effects through the headphones when Surround or DSP mode is activated—3D HEADPHONE (3D H PHONE) mode.

- “3D H PHONE” appears on the display and the DSP and HEADPHONE indicator lights up on the display. (For details, see page 36.)

Note:

When you select “DVD MULTI” as the source or any one of the Surround/DSP mode which activates the center and/or surround speaker(s), you can use only one set of the speakers.

CAUTION:

Be sure to turn down the volume:

- Before connecting or putting on headphones, as its high volume can damage both the headphones and your hearing.
- Before turning on speakers again, as its high volume may come out of the speakers.

Activating and Adjusting the Subwoofer Sound



You can cancel the subwoofer sound even though you have connected a subwoofer and have set “SUB WOOFER” to “YES” (see page 27). This is useful when enjoying surround sound at night.

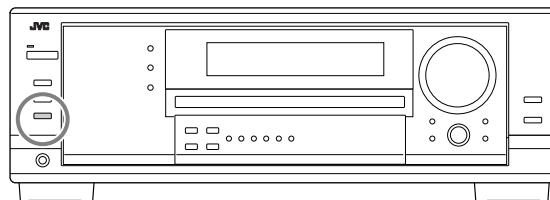

Press SUBWOOFER OUT ON/OFF to cancel the subwoofer sound output.

Each time you press the button, subwoofer sound output is deactivated (“SUBWFR OFF”) and activated (“SUBWFR ON”) alternately.

- When subwoofer sound output is activated, subwoofer output level can be adjusted using the remote control.
 - 1 Press SOUND.
 - 2 Press SUBWOOFER.
 - 3 Press LEVEL + or – to adjust the output level (–10 dB to +10 dB).

Note:

You cannot deactivate the subwoofer sound output when you set “SMALL” for the front speakers on the Speaker size setting (see page 27) or Quick Speaker Setup (see page 25).

Selecting the Analog or Digital Input Mode

When you have connected digital source components using the digital terminals (see page 16), change the input mode for these components to the digital input mode.

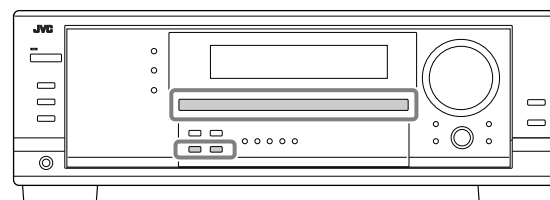

Before you start, remember...

The digital input terminal setting should be correctly done for the sources you want to select the digital input mode (see “Setting the Digital Input Terminals” on pages 29 and 30).

1. Press one of the source selection buttons for which you want to change the input mode.

- For RX-8030VBK: DVD, VIDEO, TV (SOUND)/DBS, CD, CDR, or TAPE/MD*
- For RX-7030VBK/RX-7032VSL: DVD, TV (SOUND)/DBS, CD, or TAPE/CDR*

* If “TAPE” is selected as the source, digital input mode is not available. To change the source name, see “Changing the Source Name” on page 21.

Continued on the next page

2. Press INPUT DIGITAL (or ANALOG/DIGITAL INPUT on the remote control) to select “DGTL AUTO.”

The DIGITAL AUTO indicator lights up on the display.

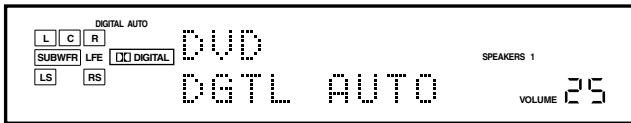

- When selecting “DGTL AUTO,” the following indicators indicate the digital signal format of the incoming signal.

LINEAR PCM : Lights up when Linear PCM signals come in.

DIGITAL : Lights up when Dolby Digital signals come in.

dts : Lights up when DTS signals come in.

No indicator lights up when the receiver cannot recognize the digital signal format of the incoming signals.

When playing software encoded with the Dolby Digital or DTS, the following symptoms may occur:

- Sound does not come out at the beginning of playback.
- Noise comes out while searching for or skipping chapters or tracks.

In this case, press INPUT DIGITAL repeatedly to select “DGTL D.D” or “DGTL DTS” while “DGTL AUTO” still remains on the display.



- As you press INPUT DIGITAL, the input mode changes as follows:

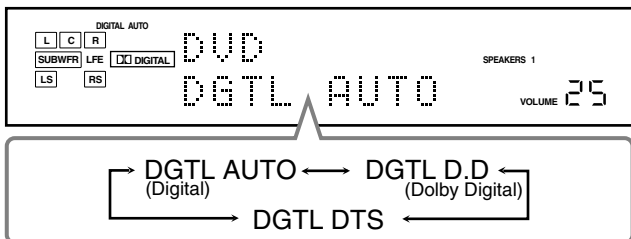

When “DGTL D.D” or “DGTL DTS” is selected, the AUTO indicator goes off, and the corresponding digital signal format indicator lights up on the display.

- If the incoming signal does not match the selected digital signal format, the frame of the selected indicator will flash.

Note:

When you turn off the power or select another source, “DGTL D.D” and “DGTL DTS” settings are canceled and the digital input mode is automatically reset to “DGTL AUTO.”

To select the analog input mode again

Press INPUT ANALOG (or press ANALOG/DIGITAL INPUT on the remote control repeatedly until “ANALOG” appears on the display). The ANALOG indicator lights up.



Setting the Dynamic Range

You can enjoy a powerful sound at night using the Midnight Mode.

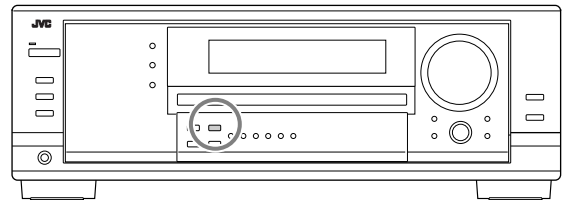

Press **MIDNIGHT MODE** so that “MID NIGHT 1” or “MID NIGHT 2” appears on the display.

The MIDNIGHT MODE indicator also lights up.

MID NIGHT 1: Select when you want to reduce the dynamic range a little.

MID NIGHT 2: Select when you want to apply the compress effect fully (useful at midnight).

MID NIGHT OFF: Select when you want to enjoy surround with its full dynamic range (no effect applied).

Notes:

- If Analog Direct is in use, Midnight Mode is temporarily canceled.
- Midnight Mode is not valid for DVD MULTI playback mode.

Attenuating the Input Signal



When the input level of the analog source is too high, the sounds will be distorted. If this happens, you need to attenuate the input signal level to prevent the sound distortion.

- Once you have made adjustment, it is memorized for each analog source.

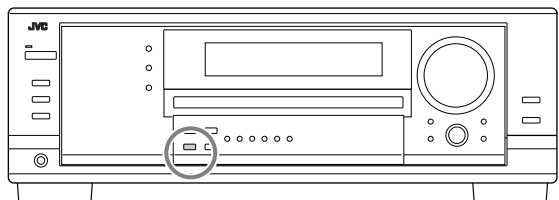

Press and hold **INPUT ATT (INPUT ANALOG)** so that the **INPUT ATT indicator lights up on the display.**

- Each time you press and hold the button, the input attenuator mode turns on (“ATT ON”) or off (“NORMAL”).

Note:

This function is not valid when “DVD MULTI” is selected or when Analog Direct is activated.

Turning Analog Direct On and Off

You can enjoy the sound closer to the original source by overriding the sound adjustments such as speaker output level adjustments (see page 32), Digital Equalization (see page 32), Surround and DSP modes (see pages 34 to 39), Bass Boost (see page 22) and Midnight Mode (see page 20). You can only adjust the volume level while Analog Direct is in use.

- Once you have made adjustment, it is memorized for each analog source.

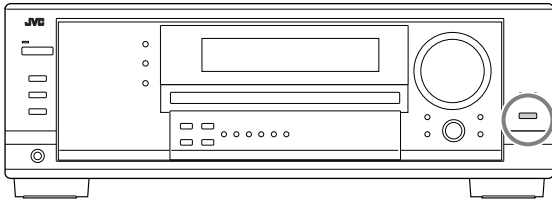

Press ANALOG DIRECT so that “A DIRECT” appears on the display.

The lamp on the button also lights up.

- Each time you press the button, Analog Direct turns on and off.

Notes:

- When digital input mode is in use, Analog Direct is not available.
- Turning on Surround or DSP mode cancels Analog Direct and previously selected sound adjustments are recalled.
- If Analog Direct is in use, Midnight Mode is temporarily canceled.
- Turning on Analog Direct cancels Input Attenuator (page 20) (and CC Converter for RX-8030VBK: below).

Making Sounds Natural



JVC's CC (Compensative Compression) Converter eliminates jitter and ripples, achieving a drastic reduction in digital distortion by processing the digital music data in 24 bit-quantization and by expanding the sampling frequency to 128 kHz (for fs 32 kHz signals)/176.4 kHz (for fs 44.1 kHz signals)/192 kHz (for fs 48 kHz signals).

By using CC Converter, you can obtain a natural sound field from both digital and analog sources.

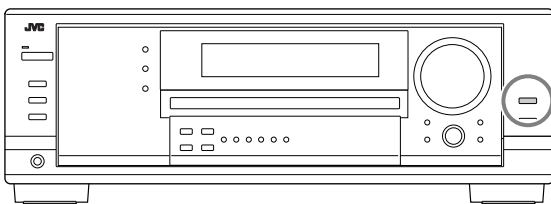

Press CC CONVERTER so that the lamp on the button lights up.

- Each time you press the button, CC Converter turns on and off (the lamp goes off) alternately.

Notes:

You cannot use this function while Analog Direct is in use. If you turn on Analog Direct while this function is in use, this function will be canceled.

Changing the Source Name



When you have connected an MD recorder to the TAPE/MD jacks or a DBS tuner to the TV SOUND/DBS jacks on the rear panel, change the source name which will be shown on the display.

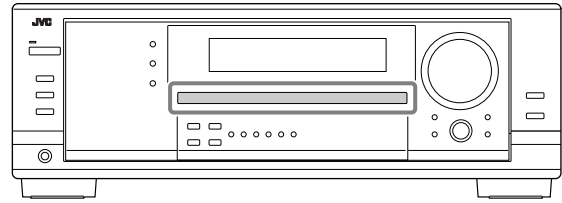

When changing the source name from “TV” to “DBS”:

1. Press TV SOUND/DBS.
 - Make sure “TV” appears on the display.
2. Press and hold TV SOUND/DBS until “ASSGN DBS” appears on the display.

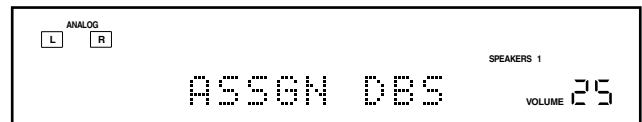

Note:

When connecting a DBS tuner to the TV SOUND/DBS IN jacks, change the source name to “DBS,” which will be shown on the display when selected as the source. Otherwise you cannot view any picture from DBS tuner.

For RX-8030VBK:

When changing the source name from “TAPE” to “MD”:

1. Press TAPE/MD.
 - Make sure “TAPE” appears on the display.
2. Press and hold TAPE/MD until “ASSGN MD” appears on the display.

For RX-7030VBK/RX-7032VSL:

When changing the source name from “TAPE” to “CDR”:

1. Press TAPE/CDR.
 - Make sure “TAPE” appears on the display.
2. Press and hold TAPE/CDR until “ASSGN CDR” appears on the display.

To change the source name to “TV” and “TAPE,” repeat the same procedure above.

Note:

Without changing the source name, you can still use the connected components. However, there may be some inconvenience.

- For RX-8030VBK:
 - “TAPE” or “TV” will appear on the display when you select the MD recorder or DBS tuner.
 - You cannot use the digital input (see pages 19 and 20) for the MD recorder.
 - You cannot use the COMPU LINK remote control system (see pages 41) to operate the MD recorder.
- For RX-7030VBK/RX-7032VSL:
 - “TAPE” or “TV” will appear on the display when you select the CD recorder or DBS tuner.
 - You cannot use the digital input (see pages 19 and 20) for the CD recorder.

The following basic operations are possible only using the remote control.

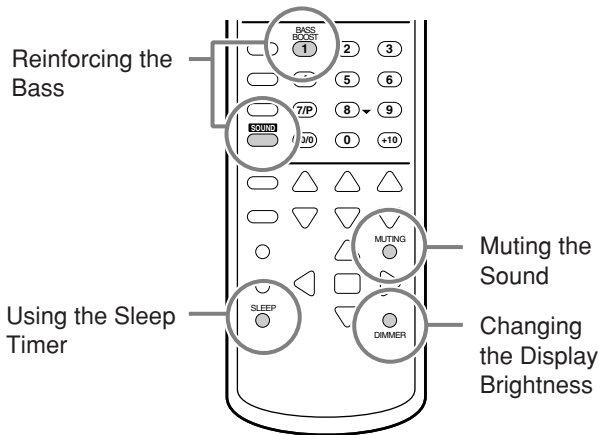

Reinforcing the Bass

You can boost the bass level.

- Once you have made adjustment, it is memorized for each source.

1. Press SOUND.

The 10 keys are activated for sound adjustments.

2. Press BASS BOOST to turn on Bass Boost.

The BASS BOOST indicator lights up.

- Each time you press the button, Bass Boost turns on (“BOOST ON”) and off (“BOOST OFF”) alternately.

For RX-7030VBK/RX-7032VSL:

You can use the BASS BOOST button on the front panel.



When the Bass Boost is activated, the lamp on the button lights up.

- Each time you press the button, Bass Boost turns on and off.

Notes:

- This function affects only the sounds from the front speakers, center speaker, and subwoofer.
- When Analog Direct is in use (see page 21), the Bass Boost is canceled temporarily.

Muting the Sound

Press **MUTING** to mute the sound through all speakers and headphones connected.

“MUTING” appears on the display and the volume turns off (the VOLUME level indicator goes off).

To restore the sound, press **MUTING** again.

- Turning MASTER VOLUME on the front panel or pressing VOLUME +/- on the remote control also restores the sound.

Changing the Display Brightness

You can dim the display.

Press **DIMMER**.

- Each time you press the button, the brightness level of the display change as follows:

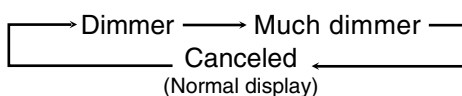

Using the Sleep Timer

Using the Sleep Timer, you can fall asleep while listening to music. When the shut-off time comes, the receiver turns off automatically.

Press SLEEP repeatedly.

The SLEEP indicator lights up on the display, and the shut-off time changes in 10 minutes intervals:

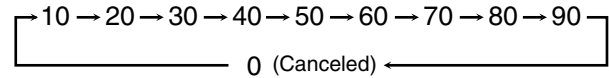

To check or change the time remaining until the shut-off time:

Press **SLEEP** once.

The remaining time until the shut-off time appears in minutes.

- To change the shut-off time, press **SLEEP** repeatedly.

To cancel the Sleep Timer:

Press **SLEEP** repeatedly until “SLEEP 0min” appears on the display. (The SLEEP indicator goes off.)

- Turning off the power also cancels the Sleep Timer.

Recording a source

For analog-to-analog recording

You can record any analog playback source onto the recording components connected to the audio output jacks on the rear of this unit at the same time.

For digital-to-digital recording

You can record the currently selected digital input source through the receiver to a digital recording device connected to the DIGITAL OUT terminal.

Notes:

- Analog-to-digital and digital-to-analog recordings are not possible.
- The output volume level, Midnight Mode (see page 20), Bass Boost (see the left column), Digital Equalization (see page 32), Surround modes and DSP modes (see pages 34 to 39) cannot affect the recording.

Basic adjustment auto memory

This receiver memorizes sound settings for each source—

- when you turn off the power,
- when you change the source, and
- when you assign the source name (see page 21).

When you change the source, the memorized settings for the newly selected source are automatically recalled.

The following can be stored for each source:

- Analog/digital input mode (see pages 19 and 20)
- Input attenuator mode (see page 20)
- Analog Direct (see page 21)
- Digital Equalization (see page 32)
- Speaker channel output levels (see page 32)
- Surround and DSP mode selection (see pages 37 and 39)
- Bass Boost setting (see the left column)

Notes:

- If the source is FM or AM, you can assign a different setting for each band.
- If you want to memorize the volume level with the above settings, set One Touch Operation to “ON” (see page 30).

Receiving Radio Broadcasts

You can browse through all the stations or use the preset function to go immediately to a particular station.

Tuning in to Stations Manually

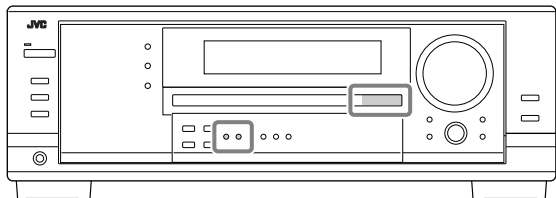

1. Press FM or AM to select the band.

The last received station of the selected band is tuned in.

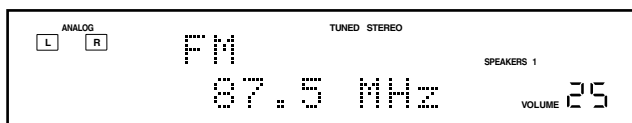

2. Press FM/AM TUNING ▲ or ▼ repeatedly until you find the frequency you want.

- Pressing FM/AM TUNING ▲ increases the frequency.
- Pressing FM/AM TUNING ▼ decreases the frequency.

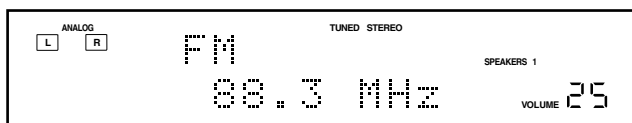

Notes:

- When a station of sufficient signal strength is tuned in, the TUNED indicator lights up on the display.
- When an FM stereo program is received, the STEREO indicator also lights up.
- When you hold and then release the button in step 2, the frequency keeps changing until a station is tuned in.

From the remote control:

1. Press FM/AM.
 - Each time you press the button, the band alternates between FM and AM.
2. Press TUNING UP or TUNING DOWN repeatedly until you find the frequency you want.
 - Pressing TUNING UP increases the frequency.
 - Pressing TUNING DOWN decreases the frequency.

Using Preset Tuning

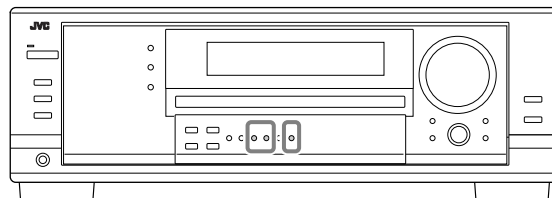

Once a station is assigned to a channel number, the station can be quickly tuned in. You can preset up to 30 FM and 15 AM stations.

To store the preset stations

Before you start, remember...

There is a time limit in doing the following steps. If the setting is canceled before you finish, start from step 2 again.

On the front panel ONLY:

1. Tune in the station you want to preset (see “Tuning in to Stations Manually” on the left).

- If you want to store the FM reception mode for this station, select the FM reception mode you want. See “Selecting the FM Reception Mode” on page 24.

2. Press MEMORY.

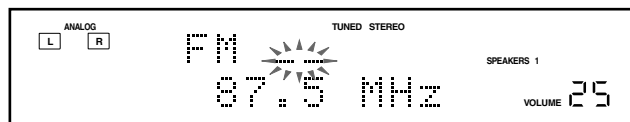

The channel number position starts flashing on the display for about 10 seconds.

3. Press FM/AM PRESET ▲ or ▼ to select a channel number while the channel number position is flashing.

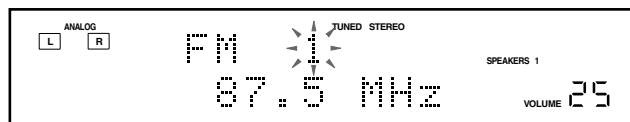

4. Press MEMORY again while the selected channel number is flashing on the display.

The selected channel number stops flashing.

The station is assigned to the selected channel number.

5. Repeat steps 1 to 4 until you store all the stations you want.

To erase a stored preset station

Storing a new station on a used number erases the previously stored one

To tune in a preset station

On the front panel:

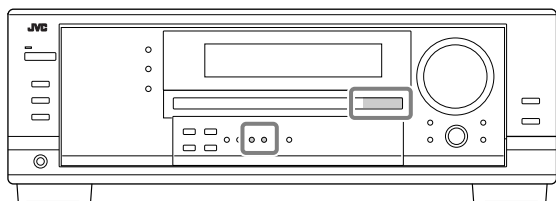

1. Press FM or AM to select the band.

The last received station of the selected band is tuned in.

2. Press FM/AM PRESET ▲ or ▼ until you find the channel you want.

- Pressing FM/AM PRESET ▲ increases the number.
- Pressing FM/AM PRESET ▼ decreases the number.

From the remote control:

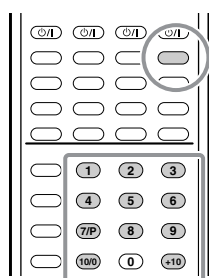

1. Press FM/AM to select the band.

The last received station of the selected band is tuned in.

- Each time you press the button, the band alternates between FM and AM.

2. Press the 10 keys to select a preset channel number.

- For channel number 5, press 5.
- For channel number 15, press +10 then 5.
- For channel number 20, press +10 then 10.
- For channel number 30, press +10, +10, then 10.

Note:

When you use the 10 keys on the remote control, be sure that they are activated for the tuner, not for the CD and others. (See page 44.)

Selecting the FM Reception Mode

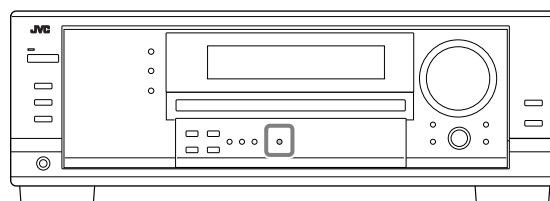

When an FM stereo broadcast is hard to receive or noisy, you can change the FM reception mode while receiving an FM broadcast.

- You can store the FM reception mode for each preset station (see page 23).

While listening to an FM station, press FM MODE.

- Each time you press the button, the FM reception mode alternates between "AUTOMUTING" and "MODE MONO."

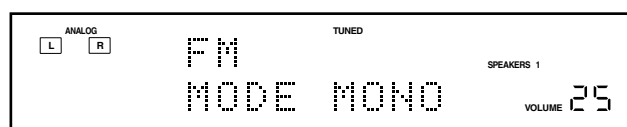
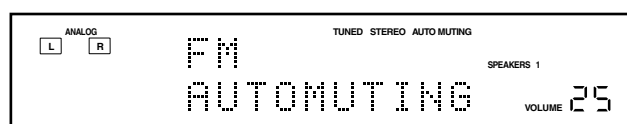

AUTOMUTING: Normally select this.
When a program is broadcasted in stereo, you will hear stereo sound; when in monaural, you will hear monaural sounds.
This mode is also useful to suppress static noise between stations. The AUTO MUTING indicator lights up on the display. (Initial setting)

MODE MONO: Select this to improve the reception (but stereo effect will be lost).
In this mode, you will hear noise while tuning into the stations. The AUTO MUTING indicator goes off from the display. (The STEREO indicator also goes off.)

Note:

When you use the FM MODE on the remote control, be sure that it is activated for the tuner, not for the CD and others. (See page 44.)

Basic Settings

Some of the following settings are required after connecting and positioning your speakers while others will make operations easier. You can use QUICK SPEAKER SETUP to easily set up your speaker configuration.

Setting the Speakers Configuration



Quick Speaker Setup helps you to easily and quickly register the speaker size and speaker distance according to your listening room to create the best possible surround effect.

- You can also register each speaker's information manually. For details, see page 27.

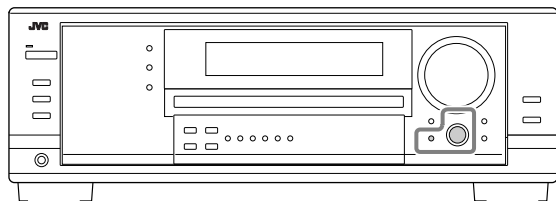

Before you start, remember...

There is a time limit in doing the following steps. If the setting is canceled before you finish, start from step 1 again.

On the front panel:

1. Press QUICK SPEAKER SETUP.

“SETUP” and “SPEAKERS?” appear on the display, then the initial setting for the total number of the connected speakers (channels) appears.

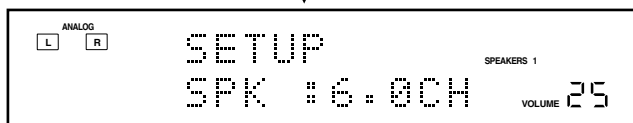

2. Turn MULTI JOG to select an appropriate number of the connected speakers (speaker channel number).

The speaker channel number changes as follows.

- For the details of speaker channel number, see “Speakers (channels) number and the size” on page 26.



2.0CH ⇄ 2.1CH ⇄ 3.0CH ⇄ 3.1CH ⇄ 4.0CH ⇄
4.1CH ⇄ 5.0CH ⇄ 5.1CH ⇄ **6.0CH*** ⇄ 6.1CH ⇄
7.0CH ⇄ 7.1CH ⇄ (Back to the beginning)

* “6.0CH” is the initial setting.

3. Press in MULTI JOG (PUSH SET).

“ROOM SIZE?” appear on the display, then the initial room size setting appears.

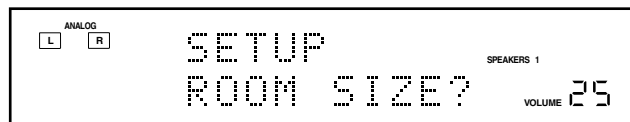

4. Turn MULTI JOG to select an appropriate room size to match to your listening room.

The room size changes as follows.

- To select your appropriate room size, see “Room size and the speaker distance” on page 26.

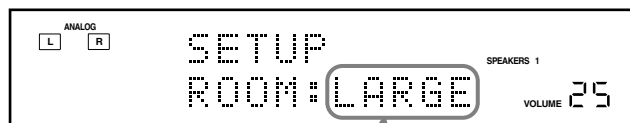

SMALL ⇄ MID ⇄ **LARGE*** ⇄ (Back to the beginning)

* “LARGE” is the initial setting.

5. Press in MULTI JOG (PUSH SET).

“COMPLETE” appears on the display, then goes back to the source indication.

- Speaker configuration settings now become active.

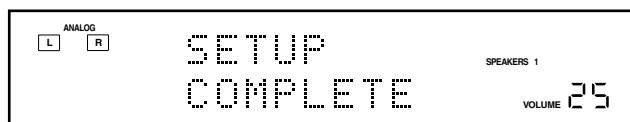

Note:

This procedure will not be completed if you stop in the middle of the setting process.

Speakers (channels) number and the size

You can find how each of the speaker size is defined according to the number of connected speakers (speaker channel (CH) number) you select.

In the following tables, “L” stands for “left front speaker,” “R” for “right front speaker,” “C” for “center speaker,” “LS” for “left surround speaker,” “RS” for “right surround speaker,” “SB” for “surround back speaker,” and “SUBWFR” for “subwoofer.”

- Subwoofer is counted as 0.1 channel.

| CH | The size of connected speakers | | | | | | |
|-----|--------------------------------|-------|-------|-------|-------|--------|--------|
| | L | R | C | LS | RS | SB | SUBWFR |
| 2.0 | LARGE | LARGE | NONE | NONE | NONE | NONE | NO |
| 2.1 | SMALL | SMALL | NONE | NONE | NONE | NONE | YES |
| 3.0 | LARGE | LARGE | SMALL | NONE | NONE | NONE | NO |
| 3.1 | SMALL | SMALL | SMALL | NONE | NONE | NONE | YES |
| 4.0 | LARGE | LARGE | NONE | SMALL | SMALL | NONE | NO |
| 4.1 | SMALL | SMALL | NONE | SMALL | SMALL | NONE | YES |
| 5.0 | LARGE | LARGE | SMALL | SMALL | SMALL | NONE | NO |
| 5.1 | SMALL | SMALL | SMALL | SMALL | SMALL | NONE | YES |
| 6.0 | LARGE | LARGE | SMALL | SMALL | SMALL | SMALL | NO |
| 6.1 | SMALL | SMALL | SMALL | SMALL | SMALL | SMALL | YES |
| 7.0 | LARGE | LARGE | SMALL | SMALL | SMALL | SMALL* | NO |
| 7.1 | SMALL | SMALL | SMALL | SMALL | SMALL | SMALL* | YES |

* This setting is applied to the both speakers.

Room size and the speaker distance

According to the selected room size, speaker distance for each activated speaker is set as follows:

| LARGE | Speaker | Distance |
|-------|---------------|---------------|
| | L | 3.0 m (10 ft) |
| R | 3.0 m (10 ft) | |
| C | 3.0 m (10 ft) | |
| LS | 3.0 m (10 ft) | |
| RS | 3.0 m (10 ft) | |
| SB | 3.0 m (10 ft) | |
| MID | Speaker | Distance |
| | L | 2.7 m (9 ft) |
| R | 2.7 m (9 ft) | |
| C | 2.4 m (8 ft) | |
| LS | 2.1 m (7 ft) | |
| RS | 2.1 m (7 ft) | |
| SB | 1.8 m (6 ft) | |
| SMALL | Speaker | Distance |
| | L | 2.4 m (8 ft) |
| R | 2.4 m (8 ft) | |
| C | 2.1 m (7 ft) | |
| LS | 1.5 m (5 ft) | |
| RS | 1.5 m (5 ft) | |
| SB | 1.2 m (4 ft) | |

Basic Setting Items

On the following pages, you can adjust the following items:

| Items | To do | See page |
|---------------------------|--|----------|
| SUB WOOFER *1 | Register your subwoofer. | 27 |
| FRONT SPEAKER *1 | Register your front speaker size. | 27 |
| CNTR SPEAKER *1 | Register your center speaker size. | 27 |
| SURR SPEAKER *1 | Register your surround speaker size. | 27 |
| SBACK SPEAKER *1 | Register your surround back speaker size. | 27 |
| SBACK OUT *1 | Register the number of the connected surround back speakers. | 27 |
| DIST UNIT | Select the measuring unit for the speaker distance. | 28 |
| FRONT DISTANCE *1 | Register the distance from you front speakers to your listening point. | 28 |
| CNTR DISTANCE *1 | Register the distance from you center speaker to your listening point. | 28 |
| SURR DISTANCE *1 | Register the distance from you surround speakers to your listening point. | 28 |
| SBACK DISTANCE *1 | Register the distance from you surround back speaker(s) to your listening point. | 28 |
| S WFR OUTPUT | Select sounds emitted from the subwoofer. | 28 |
| CROSS OVER | Select the cutoff frequency to the subwoofer. | 28 |
| LFE ATTENUATE | Attenuate the bass (LFE) sounds. | 29 |
| DUAL MONO | Select the Dual Mono sound channel. | 29 |
| DGTL IN COAX | Select the component connected to digital coaxial terminal | 29 |
| DGTL IN OPTICAL *2 | Select the components connected to digital optical terminals | 29 |
| VIDEO IN DVD | Select the type of video terminal used for the DVD player. | 30 |
| VIDEO IN DBS | Select the type of video terminal used for the DBS tuner. | 30 |
| ONE TOUCH OPE | Store the volume level for each source. | 30 |

Notes:

*1 These items can be set using Quick Speaker Setup.

*2 This setting is only for RX-8030VBK.

For RX-7030VBK/RX-7032VSL, it is automatically set according to your “DGTL IN COAX” setting.

Basic Procedure

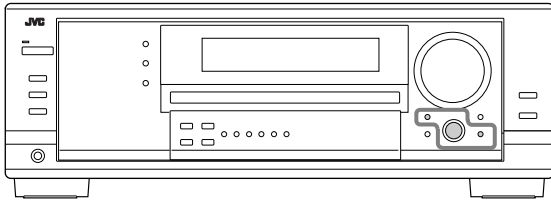

Before you start, remember...

There is a time limit in doing the following steps. If the setting is canceled before you finish, start from step 1 again.

Ex. When setting One Touch Operation to "ON:"

1. Press SETTING.

The last selected item appears on the display.



2. Turn MULTI JOG until an item you want appears on the display.

- In this example, select "ONE TOUCH OPE." For available items, see the list "Basic Setting Items" on page 26.

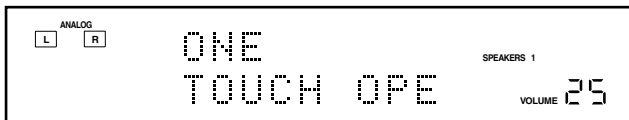

3. Push in MULTI JOG (PUSH SET).

The current setting for the selected item appears on the display.

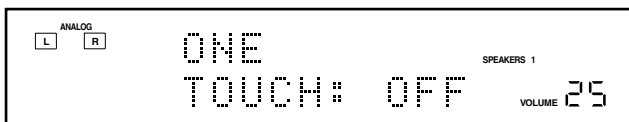

4. Turn MULTI JOG until a setting you want appears on the display.



5. Press EXIT.

6. Repeat steps 2 to 5 to set other items if necessary.

7. Press EXIT.

The source indication resumes on the display.

 : shows the initial setting in the following tables.

Setting the Speakers

To obtain the best possible surround effect from the Surround and DSP modes, register the setting about the speaker arrangement after all connections are completed.

- If you have used Quick Speaker Setup on page 25, this setting is not required.

■ Subwoofer setting—SUB WOOFER

Select whether you have connected a subwoofer or not.

YES: Select when a subwoofer is connected.

NO: Select when no subwoofer is used.

Note:

If you have selected "NO" for the subwoofer, you cannot use the SUBWOOFER OUT ON/OFF button on the front panel.

■ Speaker size—FRONT SPEAKER, CNTR SPEAKER, SURR SPEAKER, SBACK SPEAKER

Select the size for each connected speaker.

LARGE*¹: Select when the speaker size is relatively large.

SMALL*²: Select when the speaker size is relatively small.

NONE: Select this when you have not connected a speaker. (Not selectable for the front speakers)

*¹ Initial setting for front speakers.

*² Initial setting for center, surround, and surround back speakers.

Notes:

- Keep the following comments in mind as reference when adjusting.
 - If the size of the cone speaker unit built in your speaker is larger than 12 cm (4 3/4 inches), select "LARGE," and if it is smaller than 12 cm (4 3/4 inches), select "SMALL."
- If you have selected "NO" for the subwoofer setting, you can only select "LARGE" for the front speakers.
- If you have selected "SMALL" for the front speakers, you cannot select "LARGE" for the center, surround, and surround back speakers.
- If you have selected "SMALL" for the surround speakers, you cannot select "LARGE" for the surround back speakers.
- If you have selected "NONE" for the surround speakers, the surround back speakers are fixed to "NONE."

■ Surround back speakers quantity—SBACK OUT

Select the number of the surround back speakers connected.

1SPK: Select this to use 1 surround back speaker.

2SPK: Select this to use 2 surround back speakers.

Note:

If you have selected "NONE" for the surround back speakers (see above), this setting is not available.

Setting the Speaker Distance

The distance from your listening point to the speakers is another important element to obtain the best possible sound of the Surround and DSP modes. Set the distance from your listening point to the speakers.

By referring to the speaker distance setting, this unit automatically sets the delay time of the sound through each speaker so that sounds through all the speakers can reach you at the same time.

- If you have used Quick Speaker Setup on page 25, this setting is not required.

■ Measuring unit—DIST UNIT

Select which measuring unit you use.

meter: Select to set the distance in meters.

feet: Select to set the distance in feet.

■ Speaker distance—FRONT DISTANCE, CNTR DISTANCE, SURR DISTANCE, SBACK DISTANCE

Set the distance from the listening point within the range of 0.3 m (1 ft) to 9.0 m (30 ft), in 0.3 m (1 ft) intervals.

- When shipped from the factory, distance for each speaker is set to “3.0 m (10 ft).”

Notes:

- You cannot set the speaker distance for the speakers you have selected “NONE” (see page 27).
- This setting is not valid for the DVD MULTI playback mode.

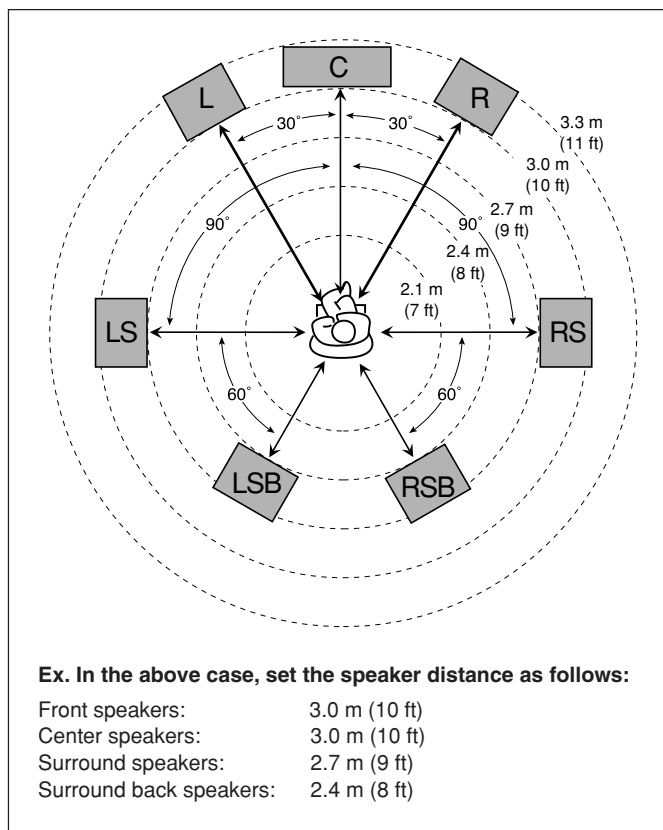

Setting the Bass Sounds

You can adjust subwoofer and bass sounds precisely according to your preference.

■ Subwoofer output—S WFR OUTPUT

You can select the type of the signal which can be transmitted through the subwoofer. In other words, you can determine whether or not the bass elements of the front speaker channels are transmitted through the subwoofer regardless of the front speaker size setting (either “SMALL” or “LARGE”).

Select one of the following:

LFE: Select to transmit only the LFE signals (while playing Dolby Digital and DTS software) and the bass elements of small speakers through the subwoofer.

LFE+MAIN: Select to always add the bass elements of the front speaker channels (MAIN) to the above (LFE) setting, and to transmit them through the subwoofer.

Note:

If you have selected “NO” for the subwoofer, this function is not available.

■ Crossover frequency—CROSS OVER

When you use a subwoofer, you can select the cutoff frequency for the small speakers used.

Select one of the crossover frequency levels according to the size of the small speaker connected.

80Hz: Select when the cone speaker unit built in the speaker is about 12 cm (4 ³/₄ inches).

100Hz: Select when the cone speaker unit built in the speaker is about 10 cm (3 ¹⁵/₁₆ inches).

120Hz: Select when the cone speaker unit built in the speaker is about 8 cm (3 ³/₁₆ inches).

150Hz: Select when the cone speaker unit built in the speaker is about 6 cm (2 ³/₈ inches).

Notes:

- If you have selected “LARGE” for all activated speakers (see page 27), this function is fixed to “OFF.”
- Crossover frequency is not valid for the DVD MULTI playback, All Channel Stereo, HEADPHONE, and 3D HEADPHONE mode.

■ **Low frequency effect attenuator—LFE ATTENUATE**

If the bass sound is distorted while playing back software encoded with Dolby Digital or DTS, set the LFE level to eliminate distortion.

Select one of the following:

| | |
|---------------|--|
| 0dB: | Normally select this. |
| -10dB: | Select when the bass sound is distorted. |

■ **Selecting main or sub channel—DUAL MONO**

Select the playback sounds (channel).

| | |
|--------------|--|
| MAIN: | Select to play back the main channel (Ch1). ^{*1} Signal indicator “L” lights up while playing back this channel. |
| SUB: | Select to play back the sub-channel (Ch2). ^{*1} Signal indicator “R” lights up while playing back this channel. |
| ALL: | Select to play back both the main and sub-channels (Ch1/Ch2). ^{*1} Signal indicators “L” and “R” light up while playing back these channels. |

Notes:

- The Dual Mono format is not identical with bilingual broadcasting or the MTS (Multichannel Television Sound) format used for TV programs. So this setting does not take effect while watching bilingual or MTS programs.
- ^{*1} Dual Mono signals can be heard from the following speakers—L (left front speaker), R (right front speaker), and C (center speaker)—with respect to the current Surround setting.

| Dual Mono Setting | Without Surround | | With Surround Activated | | | | |
|-------------------|------------------|------|-------------------------|-----------|------|-----------|-----------|
| | | | Center speaker setting | | | | |
| | L | R | SMALL/LARGE | | NONE | | |
| MAIN | Ch 1 | Ch 1 | — | Ch 1 | — | Ch 1 | Ch1 |
| SUB | Ch 2 | Ch 2 | — | Ch 2 | — | Ch 2 | Ch 2 |
| ALL | Ch 1 | Ch 2 | — | Ch 1+Ch 2 | — | Ch 1+Ch 2 | Ch 1+Ch 2 |

■ **Setting the Digital Input Terminals**

When you use the digital input terminals, register which components you have connected to the digital input terminals.

■ **Digital coaxial terminal—DGTL IN COAX**

Set the component connected to the digital coaxial terminal (DIGITAL IN 1).

- For RX-8030VBK: DVD (initial setting), MD*, CDR, TV (or DBS**) or CD.
- For RX-7030VBK/RX-7032VSL: DVD (initial setting), CD, TV (or DBS**) or CDR.

■ **Digital optical terminals—DGTL IN OPTICAL**

For RX-8030VBK:

Set the components connected to the digital optical terminals (DIGITAL IN 2 – 4).

- As you rotate MULTI JOG, the digital optical input terminals are set to used for following digital components:

When “DIGITAL IN 1 (DGTL IN COAX)” is set to “DVD”

| | | | |
|--------|------------------|--------|---|
| 2: CD | 3: TV (or DBS**) | 4: CDR | ⇄ |
| 2: CD | 3: TV (or DBS**) | 4: MD* | ⇄ |
| 2: CD | 3: MD* | 4: CDR | ⇄ |
| 2: MD* | 3: TV (or DBS**) | 4: CDR | ⇄ |

(back to the beginning)

When “DIGITAL IN 1 (DGTL IN COAX)” is set to “CD”

| | | | |
|--------|------------------|--------|---|
| 2: DVD | 3: TV (or DBS**) | 4: CDR | ⇄ |
| 2: DVD | 3: TV (or DBS**) | 4: MD* | ⇄ |
| 2: DVD | 3: MD* | 4: CDR | ⇄ |
| 2: MD* | 3: TV (or DBS**) | 4: CDR | ⇄ |

(back to the beginning)

When “DIGITAL IN 1 (DGTL IN COAX)” is set to “TV” or “DBS”**

| | | | |
|--------|--------|--------|---|
| 2: CD | 3: DVD | 4: CDR | ⇄ |
| 2: CD | 3: DVD | 4: MD* | ⇄ |
| 2: CD | 3: MD* | 4: CDR | ⇄ |
| 2: MD* | 3: DVD | 4: CDR | ⇄ |

(back to the beginning)

When “DIGITAL IN 1 (DGTL IN COAX)” is set to “CDR”

| | | | |
|--------|------------------|--------|---|
| 2: CD | 3: TV (or DBS**) | 4: DVD | ⇄ |
| 2: CD | 3: TV (or DBS**) | 4: MD* | ⇄ |
| 2: CD | 3: MD* | 4: DVD | ⇄ |
| 2: MD* | 3: TV (or DBS**) | 4: DVD | ⇄ |

(back to the beginning)

When “DIGITAL IN 1 (DGTL IN COAX)” is set to “MD”**

| | | | |
|--------|------------------|--------|---|
| 2: CD | 3: TV (or DBS**) | 4: CDR | ⇄ |
| 2: CD | 3: TV (or DBS**) | 4: DVD | ⇄ |
| 2: CD | 3: DVD | 4: CDR | ⇄ |
| 2: DVD | 3: TV (or DBS**) | 4: CDR | ⇄ |

(back to the beginning)

* When connecting an MD recorder to the digital input terminal, change the source name to “MD” from “TAPE” (see page 21).

** If you have changed the source name from “TV” to “DBS,” “DBS” appears (see page 21).

For RX-7030VBK/RX-7032VSL:

As you set the components connected to the digital coaxial terminal (DIGITAL IN 1), the optical terminals (DIGITAL IN 2 – 4) will be automatically fixed to connect the components listed below.

When “DIGITAL IN 1 (DGTL IN COAX)” is set to “DVD”

| | | |
|-------|-----------------|--------|
| 2: CD | 3: TV (or DBS*) | 4: CDR |
|-------|-----------------|--------|

When “DIGITAL IN 1 (DGTL IN COAX)” is set to “CD”

| | | |
|--------|-----------------|--------|
| 2: DVD | 3: TV (or DBS*) | 4: CDR |
|--------|-----------------|--------|

*When “DIGITAL IN 1 (DGTL IN COAX)” is set to “TV” or “DBS”**

| | | |
|--------|-------|--------|
| 2: DVD | 3: CD | 4: CDR |
|--------|-------|--------|

When “DIGITAL IN 1 (DGTL IN COAX)” is set to “CDR”

| | | |
|--------|-------|-----------------|
| 2: DVD | 3: CD | 4: TV (or DBS*) |
|--------|-------|-----------------|

* If you have changed the source name from “TV” to “DBS,” “DBS” appears (see page 21).

Setting the Component Video Input

When you use the component video inputs for connecting the DVD player and/or DBS tuner, register the type of input jacks. If you have not selected appropriate video input jacks, the AV COMPU LINK remote control system cannot operate properly. (See page 42.)

■ ***For the DVD player—VIDEO IN DVD***

Select one of the following:

COMPNT: Select when connecting the DVD player to the component video input jacks.

S/C: Select when connecting the DVD player to the composite video or S-video input jacks.

■ ***For the DBS tuner—VIDEO IN DBS***

Select one of the following:

COMPNT: Select when connecting the DBS tuner to the component video input jacks.

S/C: Select when connecting the DBS tuner to the composite video or S-video input jacks.

Memorizing the Volume Level for Each Source

This unit memorizes some settings separately for each source. In addition, you can store the volume level for each source with the other memorized settings—One Touch Operation.

■ ***One Touch Operation—ONE TOUCH OPE***

Select one of the following:

ON: Select to store the volume level separately for each source. (The ONE TOUCH OPERATION indicator lights up on the display.)

This receiver memorizes the volume level—

- when you change the source, or
- when you change the source name.

OFF: Select this not to store the volume level.

To recall the volume level

With the ONE TOUCH OPERATION indicator lit, the volume level for the currently selected source is recalled when the source is selected.

To cancel the One Touch Operation

Set One Touch Operation to “OFF” so that the ONE TOUCH OPERATION indicator goes off.

Adjusting Sound

You can make sound adjustment to your preference after completing basic setting.

Basic Setting Items

On the following pages, you can adjust the items listed below:

- You can adjust only the items applicable to the current sound mode.
- If Analog Direct is in use, you cannot make any sound adjustments.

| Items | To do | See page |
|--------------------------------|--|----------|
| DIGITAL EQ | Adjust equalizer pattern. | 32 |
| SUBWFR LVL | Adjust the subwoofer output level. | 32 |
| FRONT L LVL | Adjust the left front speaker output level. | 32 |
| FRONT R LVL | Adjust the right front speaker output level. | 32 |
| CENTER LVL | Adjust the center speaker output level. | 32 |
| SURR L LVL | Adjust the left surround speaker output level. | 32 |
| SURR R LVL | Adjust the right surround speaker output level. | 32 |
| SBACK LVL | Adjust the surround back speaker output level. | 32 |
| EFFECT*¹ | Adjust the DAP effect level. | 33 |
| ROOMSIZE*¹ | Select the room size for your virtual listening room. | 33 |
| LIVENESS*¹ | Select the liveness level for your virtual listening room. | 33 |
| CTR TONE | Make the center tone soft or sharp. | 33 |
| PANORAMA*² | Add “wraparound” sound effect with side-wall image. | 33 |
| CNTR WIDTH*² | Adjust the center channel localization between the center speaker and the left/right front speakers. | 33 |
| DIMENSION*² | Adjust sound localization position. | 33 |
| CNTR GAIN*³ | Adjust sound localization of the center channel. | 33 |

Notes:

*¹ Adjustable when the DAP mode is in use.

*² Adjustable when Pro Logic II Music is in use.

*³ Adjustable when Neo:6 Music is in use.

Basic Procedure

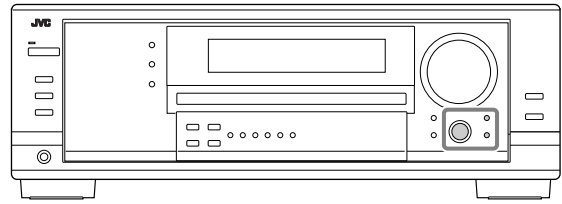

Before you start, remember..

There is a time limit in doing the following steps. If the setting is canceled before you finish, start from step 1 again.

Ex. When adjusting the subwoofer level to “-3”.

1. Press ADJUST.

The last selected item appears on the display.



2. Turn MULTI JOG until an item you want appears on the display.

- In this example, select “SUBWFR LVL.” For available items, see the list to the left.



3. Press in MULTI JOG (PUSH SET).

The current setting (or level) for the selected item appears on the display.



4. Turn MULTI JOG to select a setting you want or to make an adjustment as you like.



5. Press EXIT.

6. Repeat steps 2 to 5 to set other items if necessary.

7. Press EXIT.

The source indication resumes on the display.

Adjusting the Equalization Patterns

You can adjust the equalization patterns to your preference.

- Once you have made adjustment, it is memorized for each source.

■ **Equalization adjustment—DIGITAL EQ**

You can adjust five frequency (63 Hz, 250 Hz, 1 kHz, 4 kHz, 16 kHz) within the range of **-8 dB to +8 dB** (“0 dB” is the initial setting) in 2 dB steps.

- When adjustment is made, the DIGITAL EQ indicator lights up on the display.

To flat the equalization pattern, set all the frequency to “0 dB” in step 4 of “Basic Procedure” (on page 31). The DIGITAL EQ indicator goes off from the display.

Notes:

- When Analog Direct is in use, Digital Equalization patterns are not available.
- The Digital Equalization affects the front speaker sounds only.

You can also use the remote control for equalization adjustment.

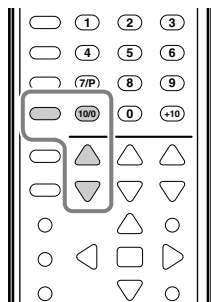

1. Press SOUND.

The 10 keys are activated for sound adjustments.

2. Press DIGITAL EQ (Equalization) repeatedly to select the center frequency you want to adjust.

- Each time you press the button, the center frequency with its current level appear on the display

3. Press LEVEL + or - repeatedly to adjust the level of the center frequency.

The DIGITAL EQ indicator lights up on the display.

- The frequency level changes from **-8 dB to +8 dB** in 2 dB steps.

4. Repeat steps 2 and 3 to adjust the other center frequency.

Adjusting the Speaker Output Levels

You can adjust the speaker output levels. The test tone comes out of each speaker except subwoofer to check the output level balance when using the Surround mode.

- Once you have made an adjustment, it is memorized for each source.

■ **Adjustable speakers**

You can adjust the following speakers’ output levels within the range of **-10 dB to +10 dB** (“0 dB” is the initial setting):

| | |
|---------------------|---|
| SUBWFR LVL: | Select to adjust the subwoofer output level. |
| FRONT L LVL: | Select to adjust the left front speaker output level. |
| FRONT R LVL: | Select to adjust the right front speaker output level. |
| CENTER LVL: | Select to adjust the center speaker output level. |
| SURR L LVL: | Select to adjust the left surround speaker output level. |
| SURR R LVL: | Select to adjust the right surround speaker output level. |
| SBACK LVL: | Select to adjust the surround back speaker output level. |

Notes:

- If you have selected “NO” or “NONE” for a speaker (see page 27), the output level for the corresponding speaker is not adjustable.
- The center speaker, and left/right surround speakers’ output levels are adjustable for DVD MULTI playback mode, even though “NONE” is selected for the speaker settings.
- Speaker output levels (except the subwoofer output level) are not adjustable when Analog Direct is in use. To adjust subwoofer output level, see page 19.

You can also use the remote control for adjusting the speaker output level.

When using the remote control, you can make an adjustment while listening to test tone.

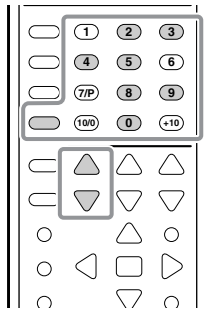

1. Press SOUND.

The 10 keys are activated for sound adjustments.

2. Press TEST to check if you can hear the sounds through all the speakers at equal level.

Test tone comes out of the speakers in the following order.

- No test tone comes out of the deactivated speakers and the subwoofer.

FRNT L (Left front speaker) → CENTER (Center speaker) →
 FRNT R (Right front speaker) →
 SURR R (Right surround speaker) →
 S BACK (surround back speaker) →
 SURR L (Left surround speaker) → (Back to the beginning)

3. Select a speaker you want to adjust.

- To select the left front speaker, press FRONT•L.
- To select the center speaker, press CENTER.
- To select the right front speaker, press FRONT•R.
- To select the right surround speaker, press SURR•R.
- To select the surround back speaker, press SURR BACK.
- To select the left surround speaker, press SURR•L.

4. Press LEVEL + or LEVEL – to adjust the speaker output level (-10 dB to +10 dB).

5. Repeat steps 3 and 4 to adjust the other speaker’s output levels.

6. Press TEST again to stop the test tone.

Adjusting the Sound Parameters for the Surround and DSP Modes

You can adjust the Surround and DSP sound parameters to your preference.

- When center speaker is set to “NONE,” CTR TONE, CNTR WIDTH, and CNTR GAIN are not available.

■ **Adjustable parameters**

You can adjust the following parameters:

For Surround, DAP, and All Channel Stereo modes (when the center speaker is connected)

- **This setting is common to all surround modes, and is memorized separately for DSP modes.**

CTR TONE: Adjust the center tone. As the number increases, the dialogue becomes clearer so that the human voices change from soft to sharp.
 (Normally select “3 (initial setting).”
 Adjustable range: **1 to 5**)

For DAP modes

- Once you have made an adjustment, it is memorized for each DAP mode.

EFFECT: Adjust the DAP effect level. As the number increases, the DAP effect becomes stronger.
 (Normally select “3 (initial setting).”
 Adjustable range: **1 to 5**)

ROOMSIZE: Adjust the virtual room size. As the number increases, the interval between reflections increases so that you will feel as if you were in a larger room.
 (Normally select “3 (initial setting).”
 Adjustable range: **1 to 5**)

LIVENESS: Adjust the liveness effect. As the number increases, the attenuation level of reflections over time decreases so that acoustics change from “Dead” to “Live.”
 (Normally select “3 (initial setting).”
 Adjustable range: **1 to 5**)

For Pro Logic II Music only

PANORAMA: Select “ON” to add “wraparound” sound effect with side-wall image. (Initial setting: “OFF”)

CNTR WIDTH: Adjust the center channel localization between the center speaker and the left/right speakers. As the number increases, the center channel sound moves toward the left and right speakers. (Normally select “3 (initial setting).” Adjustable range: **OFF and 1 to 7**)

DIMENSION: Adjust sound localization position. As the number increases, the sound localization moves towards forward from backward.
 (Normally select “4 (initial setting).”
 Adjustable range: **1 to 7**)

For Neo:6 Music only

CNTR GAIN: Adjust the sound localization of the center channel. As the number increases, center channel will be localized clearly.
 (Normally select “0.2 (initial setting).”
 Adjustable range: **0 to 0.5**)

Using the Surround Modes

This unit activates a variety of Surround modes automatically. The basic settings and adjustments stored (see pages 25 to 33) are applied.

Reproducing Theater Ambience

In a movie theater, many speakers are located on the walls to reproduce impressive multi-surround sounds, reaching you from all directions.

With these many speakers, sound localization and sound movement can be expressed.

Surround modes built in this receiver can create almost the same surround sounds as you can feel in a real movie theater—with only five to seven speakers (plus subwoofer).

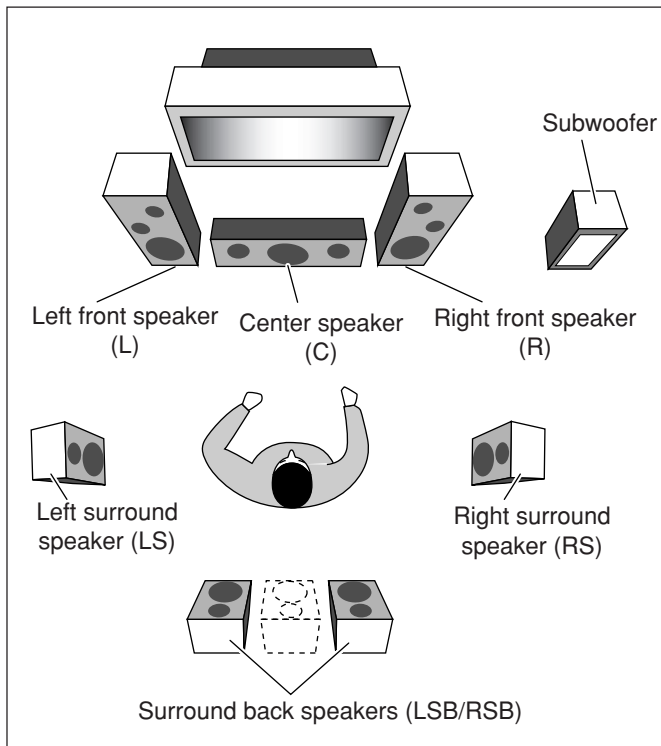
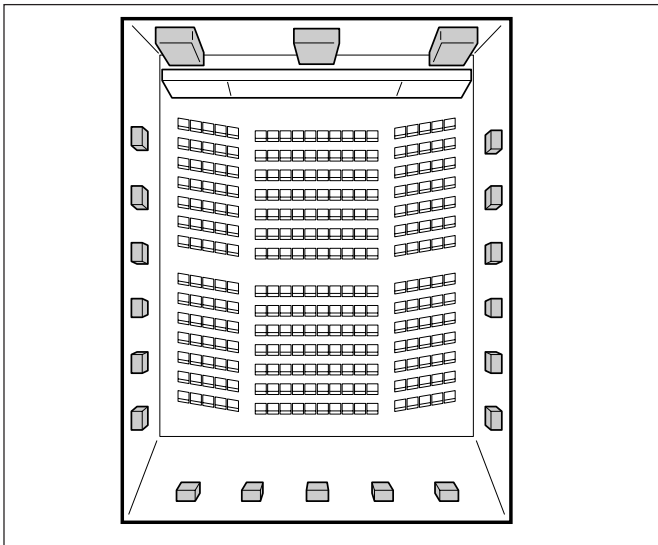

Introducing the Surround Modes

Dolby Digital*¹

Dolby Digital is a digital signal compression method, developed by Dolby Laboratories, and enables multi-channel encoding and decoding (1ch up to 5.1ch).

- When Dolby Digital signal is detected through the digital input, the  DIGITAL indicator lights up on the display.

Dolby Digital 5.1CH

Dolby Digital 5.1CH (DOLBY D) encoding method records and digitally compresses the left front channel, right front channel, center channel, left surround channel, right surround channel, and LFE channel signals (total 6 channels, but the LFE channel is counted as 0.1 channel. Therefore, called 5.1 channel).

Dolby Digital enables stereo surround sounds, and sets the cutoff frequency of the surround treble at 20 kHz, compared to 7 kHz for Dolby Pro Logic. As such, the sound movement and “being-there” feeling are enhanced much more than Dolby Pro Logic.

Dolby Digital EX

Dolby Digital EX (DOLBY D EX) is a digital surround encoding format that adds the third surround channels, called “surround back.”

Compared to the conventional Dolby Digital 5.1CH, these newly added surround back channels can reproduce more detailed movements behind you while viewing the video software. In addition, surround sound localization will become more stable.

- You can use Virtual 6.1-channel surround when playing back Dolby Digital EX software without connecting the surround back speakers. This surround reallocates the surround back channel to the surround speakers so that you can still feel the great surround effect from behind.

The VIRTUAL SB (Surround Back) indicator lights up on the display.

Dolby Pro Logic

Dolby Surround encoding format records the left front channel, right front channel, center channel, and surround channel (monaural) signals into 2 channels.

The Dolby Pro Logic (PRO LOGIC) decoder built in this receiver decodes these 2 channel signals into 4 original channel signals (plus subwoofer)—matrix-based multi-channel reproduction.

- When Dolby Pro Logic is activated, the  PRO LOGIC indicator lights up on the display.

Dolby Pro Logic II

Dolby Pro Logic II is a multi-channel playback format to convert 2-channel software into 5-channel (plus subwoofer). The matrix-based conversion method used for Dolby Pro Logic II makes no limitation for the cutoff frequency of the surround treble and enables stereo surround sound.

- This receiver provides two types of Dolby Pro Logic II modes—**Pro Logic II Movie** (PLII MOVIE) and **Pro Logic II Music** (PLII MUSIC).

When Dolby Pro Logic II is activated, the  **PRO LOGIC II** indicator lights up on the display.

PLII MOVIE: Suitable for playing any Dolby Surround encoded software. You can enjoy a sound field very close to the one created with discrete 5.1-channel sounds.

PLII MUSIC: Suitable for playing any 2-channel stereo software. You can enjoy wide and deep sounds.

DTS*2

DTS is another digital signal compression method, developed by Digital Theater Systems, Inc., and enables multi-channel encoding and decoding (1ch up to 6.1ch).

- When DTS signal is detected through the digital input, the  indicator lights up on the display.

DTS Digital Surround

DTS Digital Surround (DTS) is another discrete 5.1 channel digital audio format available on CD, LD, and DVD software.

Compared to Dolby Digital, the DTS Digital Surround format has a lower audio compression rate which enables it to add breadth and depth to the sounds reproduced. As such, DTS Digital Surround features natural, solid, and clear sound.

- When EX/ES setting is set to “ON,” DTS Neo:6 (DTS NEO:6) is applied while playing back multi-channel DTS software. It creates the same surround ambience as 6.1-channel software does.

DTS Extended Surround (DTS-ES)

DTS-ES is another multi-channel digital encoding format.

It greatly improves the 360-degree surround impression and space expression by adding the third surround channel—surround back channel.

DTS-ES includes two signal formats with different surround signal recording methods—**DTS-ES Discrete 6.1ch** (ES DSCRETE) and **DTS-ES Matrix 6.1ch** (ES MATRIX).

DTS-ES Discrete 6.1ch has been designed to encode (and decode) a 6.1-channel signal discretely to avoid interference with each channel.

DTS-ES Matrix 6.1ch has been designed to add an extra surround channel to DTS Digital Surround 5.1-channel. By using a matrix encoding/decoding method, an additional “surround back” channel signal is encoded (and decoded) in both the left and right surround channel signals.

- You can use Virtual 6.1-channel surround when playing back DTS-ES software without connecting the surround back speakers. This surround reallocates the surround back channel to the surround speakers so that you can still feel the great surround effect from behind.

The VIRTUAL SB (Surround Back) indicator lights up on the display.

DTS 96/24

In recent years, there has been increasing interest in higher sampling rates both for recording and for reproducing at home. Higher sampling rates allow wider frequency range and greater bit depths provide extended dynamic range.

DTS 96/24 is a multi-channel digital signal format (fs 96 kHz/24 bits) introduced by Digital Theater Systems, Inc. to deliver “better-than-CD sound quality” into the home.

- When DTS 96/24 signal is detected, the 96/24 indicator lights up. You can enjoy its 5.1-channel sound with full-quality.

DTS Neo:6

DTS Neo:6 is another conversion method to create 6-channel (plus subwoofer) from analog/digital 2-channel software by using the high precision digital matrix decoder used for DTS-ES Matrix 6.1ch. When one of Neo:6 modes is activated, the NEO:6 indicator lights up on the display.

- This receiver provides the following DTS NEO:6 modes—**Neo:6 Cinema** (NEO:6CINMA) and **Neo:6 Music** (NEO:6MUSIC).

NEO:6CINMA: Suitable for playing movies. You can get the same atmosphere with 2-channel software as with 6.1-channel software. It is also effective for playing software encoded with conventional surround formats.

NEO:6MUSIC: Suitable for playing music software. The front channel signals bypass the decoder (resulting in no loss of sound quality) and the surround signals transmitted through the other speakers expand the sound field naturally.

What is Dual Mono?

Dual Mono can be easily understood when you think of the bilingual broadcast or the MTS (Multichannel Television Sound) used for TV programs (however, the Dual Mono format is not identical with those analog formats).

This format is now adopted in Dolby Digital, DTS, and so on. It allows two independent channels (called main channel and sub-channel) to be recorded separately.

- When Dual Mono signal is detected, the DUAL indicator lights up. You can select either channel you want to listen to (see page 29).

When using the Surround mode, the sounds come out of the activated speakers which the Surround mode requires.

- **If the surround speakers and center speaker are set to “NONE” in the speaker setting, JVC’s original 3D-PHONIC processing (which has been developed to create the surround effect through the front speakers only) is used.** The 3D-PHONIC indicator lights up on the display.

*1 *Manufactured under license from Dolby Laboratories. “Dolby”, “Pro Logic”, and the double-D symbol are trademarks of Dolby Laboratories.*

*2 *“DTS”, “DTS-ES Extended Surround” and “Neo:6” are trademarks of Digital Theater Systems, Inc.*

Surround Modes Applicable to the Various Software

Available Surround modes vary depending on the speaker settings and the incoming signals.

The table below shows the relation of the Surround modes and the incoming signals (with the surround back speakers and EX/ES setting).

- The numbers inside the parentheses following the incoming signal type indicate the number of the front channels and that of the surround channels. For example, (3/2) indicates that the signals are encoded with three front signals (left/right/center) and two (stereo) surround signals.

| Incoming Signal Type | Surround Back Channel Setting | EX/ES Setting | Available Surround Mode |
|--|-------------------------------|---|---|
| Dolby Digital EX | 2SPK/1SPK | AUTO/ON | DOLBY D EX |
| | | OFF | DOLBY D |
| | NONE | AUTO/ON | DOLBY D (VIRTUAL SB)* ¹ |
| | | OFF | DOLBY D |
| Dolby Digital (3/2, 2/2) | 2SPK/1SPK | AUTO | DOLBY D |
| | | ON | DOLBY D EX |
| | | OFF | DOLBY D |
| | NONE | Not available | DOLBY D |
| Dolby Digital (3/1, 2/1) | 2SPK/1SPK | AUTO/ON/OFF | DOLBY D |
| | NONE | Not available | DOLBY D |
| Dolby Digital (1/0, 3/0) | 2SPK/1SPK/NONE | Not available | DOLBY D |
| Dolby Digital (Dual Mono) | 2SPK/1SPK/NONE | Not available | DUAL MONO |
| DTS-ES Discrete 6.1ch | 2SPK/1SPK | AUTO/ON | ES DSCRETE |
| | | OFF | DTS |
| | NONE | AUTO/ON | DTS (VIRTUAL SB)* ¹ |
| DTS-ES Matrix 6.1ch DTS-ES 96/24 Matrix | 2SPK/1SPK | AUTO/ON | ES MATRIX* ² |
| | | OFF | DTS |
| | NONE | AUTO/ON | DTS (VIRTUAL SB)* ¹ * ² |
| | | OFF | DTS |
| DTS, DTS 96/24 (3/2, 2/2) | 2SPK/1SPK | AUTO | DTS |
| | | ON | DTS NEO:6* ² |
| | | OFF | DTS |
| | NONE | Not available | DTS |
| DTS (3/1, 2/1) | 2SPK/1SPK | AUTO/ON/OFF | DTS |
| | NONE | Not available | DTS |
| DTS (1/0, 3/0) | 2SPK/1SPK/NONE | Not available | DTS |
| DTS (Dual Mono) | 2SPK/1SPK/NONE | Not available | DUAL MONO |
| Incoming Signal Type | | Available Surround Mode | |
| Analog/PCM/Dolby Digital (2/0)/DTS (2/0) | | PL II MOVIE / PL II MUSIC / PRO LOGIC / NEO:6 CINMA / NEO:6 MUSIC | |
| DVD MULTI | | None | |

3D HEADPHONE Mode—3D H PHONE

You can also enjoy the Surround modes through the headphones.

If you press SURROUND when the front speakers 1 and 2 are both deactivated, 3D HEADPHONE mode (3D H PHONE) is activated without respect to the type of software played back. "3D H PHONE" appears on the display and the DSP and HEADPHONE indicators also light up.

*¹ Virtual 6.1-channel surround

If you have connected (and activated) the surround speakers, you can use Virtual 6.1-channel surround when playing back Dolby Digital EX or DTS-ES software without connecting the surround back speakers. This surround reallocates the surround back channel to the surround speakers so that you can still feel the great surround effect from behind. The VIRTUAL SB (Surround Back) indicator lights up on the display.

Activating the Surround Modes

Available Surround modes vary depending on the speaker settings and the incoming signals. (See page 36.)

Activating one of the Surround modes for a source automatically recalls the memorized settings and adjustments (see pages 25 to 33.)

You can also use the buttons on the remote control for the same functions.

Activating the EX/ES setting

For multi-channel digital software, you can activate the EX/ES (7.1-channel) reproduction mode.

- Once you have set EX/ES (7.1-channel) reproduction mode, it is stored in memory and will be called up whenever you activate the Surround mode which the memorized EX/ES (7.1-channel) reproduction mode can be applied to.

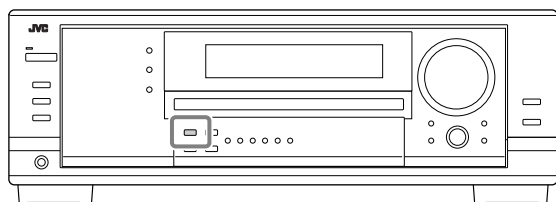

Press EX/ES to select an appropriate setting for your enjoyment. The currently selected EX/ES (7.1-channel) reproduction mode appears on the display.

- Each time you press the button, it changes as follows:

EX/ES AUTO*: According to the incoming signal, an appropriate Surround mode is applied.

- For Dolby Digital EX and DTS-ES, EX/ES (7.1-channel) reproduction is applied.
- For 5.1-channel (or less) encoded software, 5.1-channel reproduction is applied.

EX/ES ON*: Select to apply EX/ES (7.1-channel) reproduction to both 5.1-channel and 6.1-channel encoded software.

EX/ES OFF: Select to cancel the EX/ES (7.1-channel) reproduction.

* If the surround back speakers are not connected or deactivated, Virtual 6.1-channel surround is applied.

Notes:

- When Surround mode is deactivated, pressing EX/ES will activate an appropriate Surround mode for the current source.
- When an analog or digital 2-channel source is playing, you can adjust the EX/ES (7.1-channel) reproduction mode and store the setting, but it will not affect the current source.
- When the source is one to which the EX/ES (7.1-channel) reproduction cannot be applied, you can adjust the setting and store in memory, but reproduction channels will remain unchanged.

Activating the Surround Modes

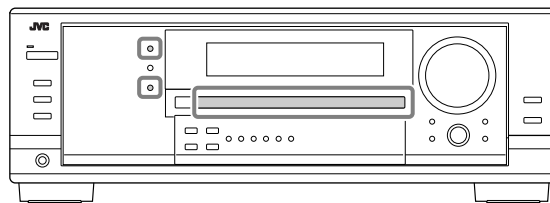

1. Select and play any source other than "DVD MULTI."

- Make sure you have selected the analog or digital input mode.
- Surround modes are not valid for DVD MULTI playback mode.

2. Press SURROUND to activate the Surround mode.

- For multi-channel digital software (except 2-channel and Dual Mono software),** incoming signals are automatically detected and the appropriate surround mode is activated (see page 36 for details).

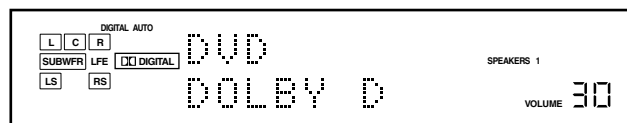

Ex. When "DOLBY D" is activated.

- If the EX/ES (7.1-channel) reproduction mode has been set to "AUTO" or "ON," one of the EX/ES (7.1-channel) reproduction modes will be activated (see the left column).

- For analog sources and digital 2-channel software,** you can select one of the following Surround modes. Each time you press SURROUND, Surround modes change as follows:

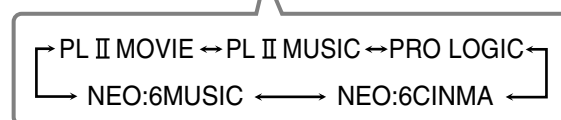

- For Dual Mono software,** you can select the channel you listen to. (See page 29.)

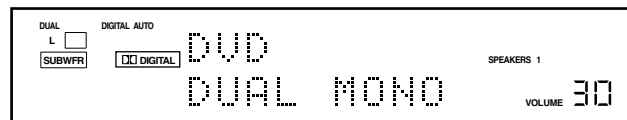

To adjust the speaker output level, see pages 32 and 33.

To cancel the Surround mode

Press SURROUND/DSP OFF (or SURR/DSP OFF on the remote control). "SURR OFF" appears on the display.

Using the DSP Modes

This unit activates a variety of DSP modes automatically. The basic settings and adjustments stored (see pages 25 to 33) are applied automatically.

Reproducing the Sound Field

The sound heard in a concert hall, club, etc. consists of direct sound and indirect sound—early reflections and reflections from behind. Direct sounds reach the listener directly without any reflection. On the other hand, indirect sounds are delayed by the distances of the ceiling and walls. These direct sounds and indirect sounds are the most important elements of the acoustic surround effects. The DSP modes can create these important elements, and give you a real “being there” feeling.

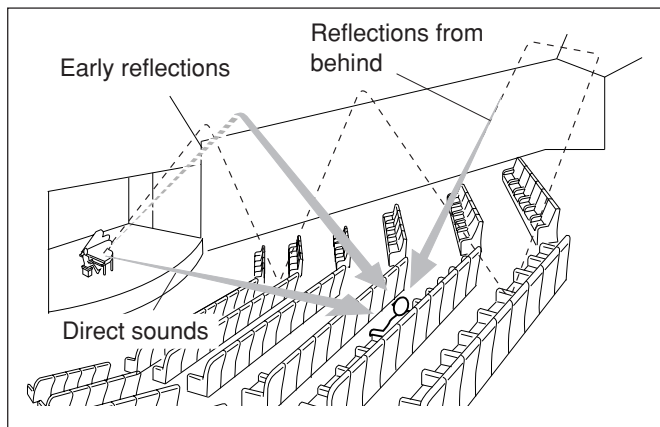

Introducing the DSP Modes

The DSP modes include the following modes—

- DAP (Digital Acoustic Processor) modes (HALL 1, HALL 2, LIVE CLUB, DANCE CLUB, PAVILION, THEATER 1, THEATER 2)
- ALL CH STEREO
- MONO FILM

3D HEADPHONE Mode

You can also enjoy the DSP effect (except All Channel Stereo mode) through the headphones.

If you press DSP when the front speakers 1 and 2 are both deactivated, 3D HEADPHONE mode is activated without respect to the type of software played back. “3D H PHONE” appears on the display and the DSP and HEADPHONE indicators also light up.

To use the DSP modes, press DSP so that the DSP modes change as follows.

The DSP indicator also lights up on the display.

| | | |
|--|-------------|--------------|
| → HALL 1 | → HALL 2 | → LIVE CLUB |
| → DANCE CLUB | → PAVILION | → ALL STEREO |
| → THEATER 1 | → THEATER 2 | → MONO FILM |
| → (Back to the beginning) | | |
| <input type="checkbox"/> : Suitable for audio sources <input type="checkbox"/> : Suitable for video sources | | |

DAP modes

You can use the following DAP modes in order to reproduce a more acoustic sound field in your listening room.

| | |
|--------------------|---|
| HALL 1: | Reproduces the spatial feeling of a large shoebox-shaped hall designed primarily for classical concerts. (Its seating capacity is about 2000.) |
| HALL 2: | Reproduces the spatial feeling of a large vineyard-shaped hall designed primarily for classical concerts. (Its seating capacity is about 2000.) |
| LIVE CLUB: | Reproduces the spatial feeling of a live music club with a low ceiling. |
| DANCE CLUB: | Reproduces the spatial feeling of a rocking dance club. |
| PAVILION: | Reproduces the spatial feeling of an exhibition hall with a high ceiling. |
| THEATER 1*: | Reproduces the spatial feeling of a large theater where the seating capacity is about 600. |
| THEATER 2*: | Reproduces the spatial feeling of a small theater where the seating capacity is about 300. |

* The built-in Dolby Pro Logic II decoder is activated when playing back 2-channel analog or digital source. The **PRO LOGIC II** indicator lights up.

When using the DAP mode, the sounds come out of all the connected and activated speakers.

- If surround speakers are set to “NONE” in the speaker setting, JVC’s original 3D-PHONIC processing (which has been developed to create the surround effect through the front speakers only) is used.

The 3D-PHONIC indicator lights up on the display.

ALL Channel Stereo mode

This mode can reproduce a larger stereo sound field using all the connected (and activated) speakers. **This mode cannot be used without activating the surround speakers.**

- If the front speakers are deactivated, "All Channel Stereo" cannot be selected.

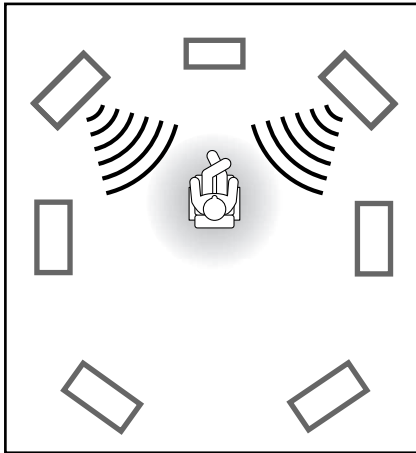

Sound reproduced from normal stereo

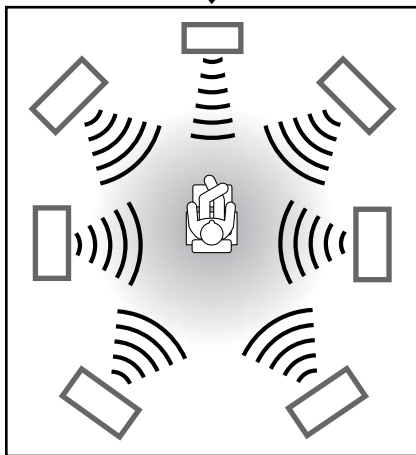

Sound reproduced from All Channel Stereo mode

Monaural Film

In order to reproduce a more acoustic sound field in your listening room while viewing monaural sound video software (analog and 2-channel digital signals), you can use this mode.

The surround effect will be added, and the sound localization of actor's words will be improved. **This mode cannot be used for multi-channel digital signals.**

When "MONO FILM" is used, sounds come out of all the connected (and activated) speakers.

- If incoming signals change from 2-channel digital signal to another digital signal type, "MONO FILM" is canceled and an appropriate Surround mode is activated.

Activating the DSP Modes

Activating one of the DSP modes for a source automatically recalls the memorized settings and adjustments (see pages 25 to 33.)

You can also use the buttons on the remote control for the same functions.

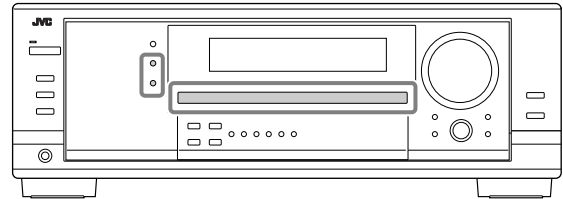

1. Select and play any sound source.
2. Press DSP repeatedly until the DSP mode you want appears on the display.
 - Each time you press the button, the DSP modes change as follows:

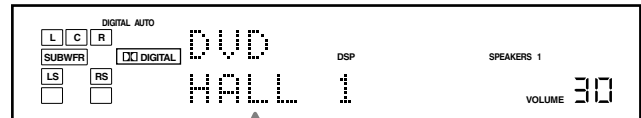

- | | | |
|---------------------------|-------------|---------------|
| → HALL 1 | → HALL 2 | → LIVE CLUB |
| → DANCE CLUB | → PAVILION | → ALL STEREO* |
| → THEATER 1 | → THEATER 2 | → MONO FILM** |
| → (Back to the beginning) | | |

* When surround speakers are set to "NONE," you cannot select "ALL STEREO."

** When multi-channel signals come in, you cannot select "MONO FILM."

Note:

When the surround speakers are deactivated, the 3D-PHONIC processing is applied to the DSP modes (the 3D-PHONIC indicator also lights up).

To cancel the DSP modes

Press SURROUND/DSP OFF (or SURR/DSP OFF on the remote control). "SURR OFF" appears on the display.

- When the front speakers are deactivated, "HEADPHONE" will appear.

Using the DVD MULTI Playback Mode

This receiver provides the DVD MULTI playback mode for reproducing the analog discrete output mode of the DVD player.

Connection diagram

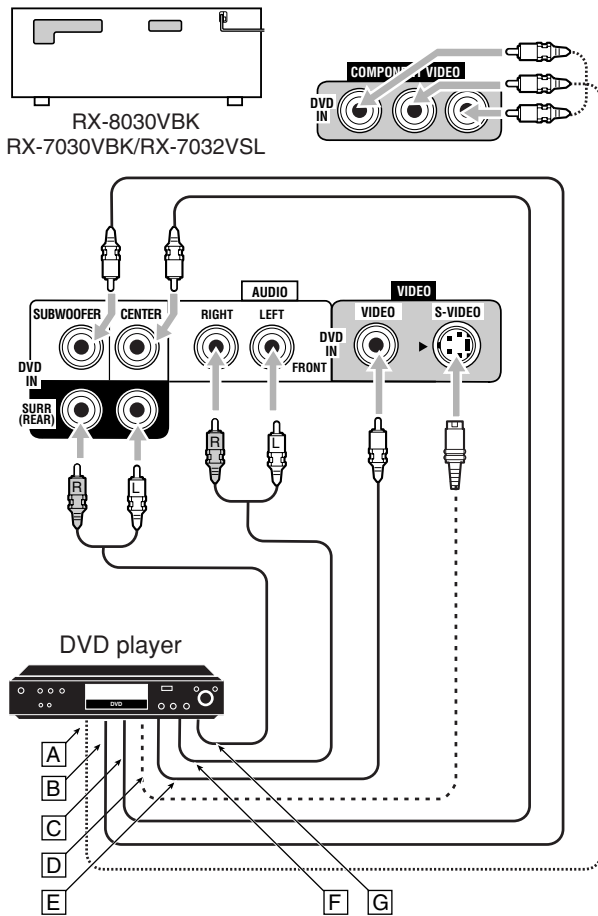

- A To component video output
- B To subwoofer output
- C To center channel audio output
- D To S-video output
- E To composite video output
- F To left/right front channel audio output
- G To left/right surround channel audio output

Note:

When connecting a DVD player to the component video input jacks, make the component video input setting correctly. See page 30 for details.

Activating the DVD MULTI Playback Mode

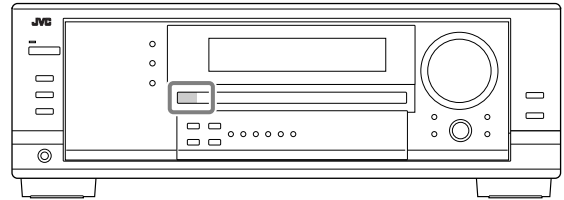

1. Press DVD MULTI so that "DVD MULTI" appears on the display.

The MULTI indicator also lights up.

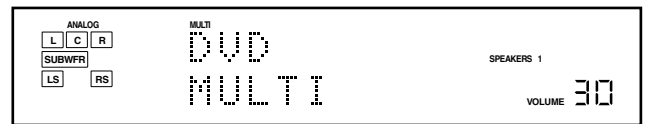

Note:

When you select "DVD MULTI" as the source to play, the Surround and DSP modes are canceled, and the SURROUND and DSP buttons do not work.

2. Select the analog discrete output mode on the DVD player, and start playing a DVD.

- Refer also to the manual supplied with the DVD player.

You can adjust Digital Equalization patterns and speaker output levels. See "Adjusting the Equalization Patterns" on page 32 for details.

Notes:

- Midnight Mode is not available for DVD MULTI playback mode (see page 20).
- When using a headphones, you can listen to the front channels (left and right) only.

COMPU LINK Remote Control System

The COMPU LINK remote control system allows you to operate JVC's audio components through the remote sensor on the receiver.

To use this remote control system, you need to connect JVC's audio components through the COMPU LINK (SYNCHRO) jacks (see below) in addition to the connections using cables with RCA pin plugs (see pages 12 and 13).

- Make sure that the AC power cords of these components are unplugged before connection. Plug the AC power cords only after all connections are complete.

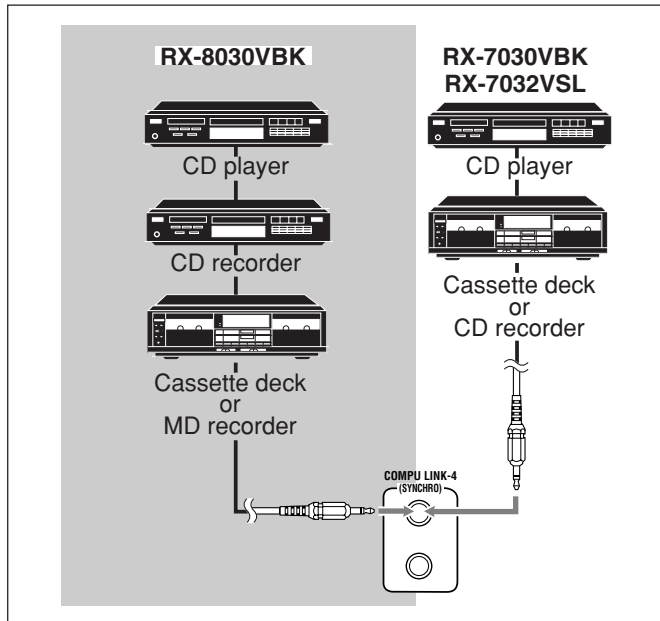

Notes:

- There are four versions of COMPU LINK remote control system. This receiver is equipped with the fourth version—COMPU LINK-4. This version is added systematic operations with the CD recorder to the previous version—COMPU LINK-3.
- If your audio component has two COMPU LINK jacks, you can use either one. If it has only one COMPU LINK jack, connect it so that it is the last item in the series of components.
- To operate the target component using the COMPU LINK remote control system, set the source name correctly if required. (See page 21.)
- Refer also to the manuals supplied with your audio components.

This remote control system allows you to use four functions listed below.

Remote Control through the Remote Sensor on the Receiver

You can control the connected audio components through the remote sensor on the receiver using this remote control. Aim the remote control directly at the remote sensor on the receiver. For details, see pages 44 and 45.

Automatic Source Selection

When you press the play (▶) button on a connected component or on its own remote control, the receiver automatically turns on and changes the source to the component. On the other hand, if you select a new source on the receiver or on the remote control, the selected component begins playing immediately. In both cases, the previously selected source continues playing without sound for a few seconds.

- For RX-7030VBK/RX-7032VSL: You cannot use the COMPU LINK remote control system to operate the MD recorder.

Automatic Power On/Off (Standby)—only possible with the COMPU LINK-3 and COMPU LINK-4

The connected components turn on and off (standby) along with the receiver.

When you turn on the receiver, one of the connected components will turn on automatically, depending on which component has been previously selected.

When you turn off the receiver, the connected components will turn off (standby).

Synchronized Recording

Synchronized recording means the cassette deck (or MD recorder) starts recording as soon as a CD begins playing.

To use synchronized recording, follow these steps:

1. Put a tape in the cassette deck (or an MD in the MD recorder), and a disc in the CD player.
2. Press the record (●) button and the pause (II) button on the cassette deck (or MD recorder) at the same time.
This puts the cassette deck (or MD recorder) into recording pause.
If you do not press the record (●) button and pause (II) button at the same time, the synchronized recording feature will not operate.
3. Press the play (▶) button on the CD player.
The source changes on the receiver, and as soon as play starts, the cassette deck (or MD recorder) starts recording. When the play ends, the cassette deck (or MD recorder) enters recording pause, and stops about 4 seconds later.

Notes:

- During synchronized recording, the selected source cannot be changed.
- If the power of any component is shut off during synchronized recording, the COMPU LINK remote control system may not operate properly. In this case, you must start again from the beginning.

AV COMPU LINK Remote Control System

The AV COMPU LINK remote control system allows you to operate JVC's video components (TV, VCR, and DVD player) through the receiver.

This receiver is equipped with the AV COMPU LINK-III, which adds a function to the previous version in order to operate JVC's video components through the video components terminals. To use this remote control system, connect the video components you want to operate, following the diagrams below and the procedure on the next page.

CONNECTIONS 1: AV COMPU LINK Connection

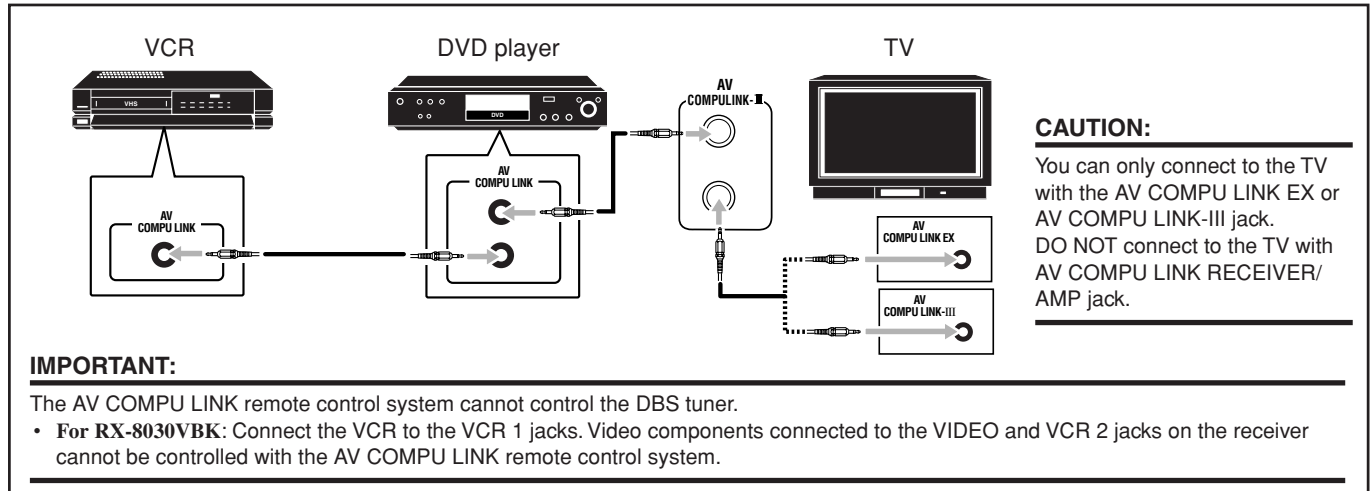

Notes:

- When connecting the receiver and a TV with the AV COMPU LINK EX terminal by using a component video cable, you cannot use automatic selection of TV's input mode (see page 43).
- When connecting only the VCR or DVD player to this receiver, connect it directly to the receiver using cables with the monaural mini-plugs.

CONNECTIONS 2: Video Cable Connection

This receiver is equipped with three types of the video terminals—S-video, composite video, and component video, and the signals coming into this receiver through one type of video jacks can output only through the jack of the same type. So you need to connect the VCR and/or DVD player to the TV using one of the following three ways:

- When using the AV COMPU LINK remote control system, set the component video input for the DVD player and the DBS tuner correctly (see "Setting the Component Video Input" on page 30); otherwise, the correct input for this receiver will not be selected on the TV.

| | |
|--------|--|
| CASE 1 | <p>When connecting the source equipment to the receiver through the S-video jacks, connect this receiver to the TV's Video Input 1 jack using S-video cables.</p> |
| CASE 2 | <p>When connecting the source equipment to the receiver through the composite video jacks, connect this receiver to the TV's Video Input 2 jack (composite video input) using composite video cables.</p> |
| CASE 3 | <p>When connecting the source equipment to the receiver through the component video jacks, connect this receiver to the TV's Video Input 2 jack (component video input) using component video cables.</p> |

1. **If you have already plugged your VCR , DVD player, TV and this receiver into the AC outlets, unplug their AC power cords first.**
2. **Connect your VCR, DVD player, TV and this receiver, using the cables with the monaural mini-plugs (not supplied).**
 - See “CONNECTIONS 1” on the previous page.
3. **Connect the audio input/output jacks on VCR, DVD player, TV and this receiver using the cables with RCA pin plugs.**
 - See pages 14 and 15.
4. **Connect the video input/output jacks on VCR, DVD player, TV and this receiver, using the cables with RCA pin plugs, S-video plug or component video plugs.**
 - See “CONNECTIONS 2” on the previous page.
5. **Plug the AC power cords of the components and the receiver into the AC outlets.**
6. **When turning on the TV for the first time after the AV COMPU LINK connection, turn the TV volume to the minimum using the TV volume control on the TV.**
7. **Turn on the connected components first, then turn on this receiver.**
 - When turning on the VCR, use the remote control supplied with this receiver.

The AV COMPU LINK remote control system allows you to use the five basic functions listed below.

Remote Control of the TV, DVD player, and VCR Using This Remote Control

See page 46 for details.

- Aim the remote control directly at the remote sensor on each target component.

One-Touch Video Play

Simply by inserting a video cassette without its safety tab into the VCR, you can enjoy the video playback without setting other switches manually. The receiver automatically turns on and changes the source to “VCR 1” (for RX-8030VBK) or “VCR” (for RX-7030VBK/RX-7032VSL).

The TV automatically turns on and changes the input mode to the appropriate position so that you can view the playback picture.

When you insert a video cassette with its safety tab, press the play (▶) button on the VCR or on the remote control. So, you can get the same result.

One-Touch DVD Play

Simply by starting playback on the DVD player, you can enjoy the DVD playback without setting other switches manually.

- When the DVD player is connected through the analog input jacks on this receiver (and analog input is selected), the receiver automatically turns on and changes the source to “DVD” or “DVD MULTI.”
 - When the DVD player is connected through the digital input terminal on this receiver (and digital input is selected), the receiver automatically turns on and changes the source to “DVD.”
- The TV automatically turns on and changes the input mode to the appropriate position so that you can view the playback picture.

Automatic Selection of TV's Input Mode

- When you select “TV” as the source to play on the receiver, the TV automatically changes the input mode to the TV tuner so that you can watch TV.
- When you select any other video source other than “TV” as the source to play on the receiver, the TV automatically changes the input mode to the appropriate position (either Video Input 1 or Video Input 2) so that you can view the playback picture.

Notes:

- *When you select “TV” as the source on the receiver, you cannot see the menu on the TV screen since the AV COMPU LINK remote control system automatically changes the TV's input mode to the TV tuner.*
- *This function does not work when you connect this receiver and the TV with the AV COMPU LINK EX terminal using a component video cable. In this case, reconnect the TV referring to case 1 or case 2 on page 42.*

Automatic Power On/Off

The TV, VCR, and DVD player turn on and off along with the receiver.

When you turn on the receiver;

- If the previously selected source is “VCR 1” (for RX-8030VBK) or “VCR” (for RX-7030VBK/RX-7032VSL), the TV and VCR will turn on automatically.
- If the previously selected source is “DVD” or “DVD MULTI,” the TV and DVD player will turn on automatically.
- If the previously selected source is any video source other than the above, only the TV will turn on automatically.

When you turn off the receiver, the TV, VCR and the DVD player will turn off.

Note:

If you turn off the receiver while recording on the VCR, the VCR will not turn off, but continue recording.

Operating JVC's Audio/Video Components

You can operate JVC's audio and video components with this receiver's remote control, since control signals for JVC's components are preset in the remote control.

Operating Audio Components

IMPORTANT:

To operate JVC's audio components using the supplied remote control:

- You need to connect JVC's audio components through the COMPU LINK (SYNCHRO) jacks (see page 41) in addition to the connections using cables with RCA pin plugs (see pages 11 to 13).
- Aim the remote control directly at the remote sensor on the receiver.
- If you use the buttons on the front panel to choose a source, the remote control will not operate that source. To operate a source with the remote control, the source must be selected using source selection buttons on the remote control.
- To operate the target component using the COMPU LINK remote control system, set the source name correctly if required. (See page 21.)
- Refer also to the manuals supplied with your components.

For RX-8030VBK:

- When you press one of the source selection buttons, the remote operation mode appears on the display window for about two hours.



| Buttons | Indications | | | | | | | | |
|-----------------------|--|---|-------|---|------|---|-------|---|-----|
| FM/AM | TUNER | | | | | | | | |
| CD | CD | | | | | | | | |
| CDR | CDR | | | | | | | | |
| PHONO | PHONO | | | | | | | | |
| TAPE/MD | TAPE | | | | | | | | |
| CONTROL (repeatedly)* | <table border="0"> <tr> <td>→</td> <td>VCR 1</td> <td>→</td> <td>TAPE</td> </tr> <tr> <td>←</td> <td>CDDSC</td> <td>←</td> <td>CDR</td> </tr> </table> | → | VCR 1 | → | TAPE | ← | CDDSC | ← | CDR |
| → | VCR 1 | → | TAPE | | | | | | |
| ← | CDDSC | ← | CDR | | | | | | |
| SOUND | SOUND | | | | | | | | |

* By pressing CONTROL repeatedly, you can select "VCR 1," "TAPE," "CDR" or "CDDSC" as the source.

- When you press one of the following buttons, the remote operation mode appears on the display window for about two hours.

| Buttons | Indications |
|------------|-------------|
| FRONT•L | FRL |
| FRONT•R | FRR |
| CENTER | CTR |
| SURR•L | SURRL |
| SURR•R | SURRR |
| SURR BACK | SBK |
| SUBWOOFER | S-WFR |
| DIGITAL EQ | EQ |

Tuner

You can always perform the following operations:

FM/AM: Alternate between FM and AM.

After pressing FM/AM, you can perform the following operations on a tuner:

- 1 – 10/0, +10: Select a preset channel number directly.
 For channel number 5, press 5.
 For channel number 15, press +10, then 5.
 For channel number 20, press +10, then 10/0.

TUNING UP/DOWN:

Tune into stations.

FM MODE: Change the FM reception mode.

Sound control section (Amplifier)

You can always perform the following operations:

SURROUND: Turn on and select Surround modes

DSP: Turn on and select DSP modes.

SURR/DSP OFF: Turn off Surround and DSP modes.

After pressing SOUND, you can perform the following operations:

FRONT•L then LEVEL +/-: Adjust the left front speaker output level.

FRONT•R then LEVEL +/-: Adjust the right front speaker output level.

CENTER then LEVEL +/-: Adjust the center speaker output level.

SURR•L then LEVEL +/-: Adjust the left surround speaker output level.

SURR•R then LEVEL +/-: Adjust the right surround speaker output level.

SURR BACK: Adjust the surround back speaker output level.

SUBWOOFER then LEVEL +/-: Adjust the subwoofer output level.

DIGITAL EQ then LEVEL +/-: Select the sound frequency bands and adjust its level.

TEST: Turn on or off test tone output.

BASS BOOST: Turn on or off Bass Boost.

Note:

After adjusting sounds, press the corresponding source selection button to operate your target source by using the 10 keys; otherwise, the 10 keys cannot be used for operating your target source.

CD player

After pressing CD, you can perform the following operations on a CD player:

▶: Start playing.

◀◀: Return to the beginning of the current (or previous) track.

▶▶: Skip to the beginning of the next track.

■: Stop playing.

||: Pause playing. To resume, press ▶.

1 – 10/0, +10:

Select a track number directly.

For track number 5, press 5.

For track number 15, press +10, then 5.

For track number 20, press +10, then 10/0.

For track number 30, press +10, +10, then 10/0.

CD changer

For RX-8030VBK:

After selecting "CDDSC" by pressing CONTROL repeatedly, you can perform the following operations on a CD changer:

For RX-7030VBK/RX-7032VSL:

After pressing CD DISC, you can perform the following operations on a CD changer:

- ▶: Start playing.
- ◀◀: Return to the beginning of the current (or previous) track.
- ▶▶: Skip to the beginning of the next track.
- : Stop playing or recording.
- ||: Pause playing. To resume, press ▶.
- 1 – 6, 7/P: Select the number of a disc installed in a CD changer.

After pressing CD, you can perform the following operations on a CD changer:

- 1 – 10/0, +10: Select a track number directly.
 - For track number 5, press 5.
 - For track number 15, press +10, then 5.
 - For track number 20, press +10, then 10/0.
 - For track number 30, press +10, +10, then 10/0.

Example:

- Selecting disc number 4, track number 12, and starting playback.

For RX-8030VBK:

1. Press CONTROL repeatedly until "CDDSC" appears on the display window, then press 4.
2. Press CD, then press +10, 2.

For RX-7030VBK/RX-7032VSL:

1. Press CD DISC, then press 4.
2. Press CD, then press +10, 2.

If your CD changer is of 200-disc loading capability (except for XL-MC100 and XL-MC301), you can do the following operations using the 10 keys after pressing CD.

1. Select a disc number.
2. Then select a track number (always enter two digits).
3. Start playback.

Examples:

- Selecting disc number 3, track number 2, and starting playback. Press 3, then, 0, 2, then ▶.
- Selecting disc number 10, track number 5, and starting playback. Press 1, 0, then, 0, 5, then ▶.
- Selecting disc number 105, track number 12, and starting playback. Press 1, 0, 5, then 1, 2, then ▶.

Turntable

After pressing PHONO, you can perform the following operations on a turntable:

- ▶: Start playing.
- : Stop playing.



CD recorder

For RX-8030VBK: After pressing CDR (or selecting "CDR" by pressing CONTROL repeatedly), you can perform the following operations on a CD recorder:

For RX-7030VBK/RX-7032VSL: After pressing TAPE/CDR (or TAPE/CDR CONTROL), you can perform the following operations on a CD recorder:

- ▶: Start playing.
- ◀◀: Return to the beginning of the current (or previous) track.
- ▶▶: Skip to the beginning of the next track.
- : Stop playing or recording.
- ||: Pause playing. To resume, press ▶.
- 1 – 10/0, +10: Select a track number directly.
 - For track number 5, press 5.
 - For track number 15, press +10, then 5.
 - For track number 20, press +10, then 10/0.
 - For track number 30, press +10, +10, then 10/0.
- REC PAUSE: Enter recording pause by pressing this button. To start recording again, press this button then ▶.

Cassette deck

For RX-8030VBK: After pressing TAPE/MD (or selecting "TAPE" by pressing CONTROL repeatedly), you can perform the following operations on a cassette deck:

For RX-7030VBK/RX-7032VSL: After pressing TAPE/CDR (or TAPE/CDR CONTROL), you can perform the following operations on a cassette deck:

- ▶: Start playing.
- REW: Fast wind the tape from right to left.
- FF: Fast wind the tape from left to right.
- : Stop playing or recording.
- ||: Pause playing. To resume, press ▶.
- REC PAUSE: Enter recording pause by pressing this button. To start recording again, press this button then ▶.

MD recorder

After pressing TAPE/MD (or selecting "TAPE*" by pressing CONTROL repeatedly), you can perform the following operations on a MD recorder:



- ▶: Start playing.
- ◀◀: Return to the beginning of the current (or previous) track.
- ▶▶: Skip to the beginning of the next track.
- : Stop playing or recording.
- ||: Pause playing. To resume, press ▶.
- REC PAUSE: Enter recording pause by pressing this button. To start recording again, press this button then ▶.

* Selecting "TAPE" will allow you to control the MD recorder.

Note:

You can use either source selection buttons or the control button (CONTROL for RX-8030VBK or TAPE/CDR CONTROL for RX-7030VBK/RX-7032VSL) to activate the buttons for the target source. If you press one of the source selection buttons, the playing source also changes. On the other hand, pressing the control button does not change the playing source.

Operating Video Components

IMPORTANT:

To operate JVC's video components using the supplied remote control:

- You need to connect JVC's video components through the AV COMPU LINK jacks (see page 42) in addition to the connections using cables with RCA pin plugs (see pages 14 and 15).
- Some JVC's VCRs can accept two types of the control signals—remote code "A" and "B." Before using this remote control, make sure that the remote control code of the target VCR is set to code "A."
 - For **RX-8030VBK**: When another JVC's VCR is connected to the VCR 2 or VIDEO terminals, set its remote control code to code "B." (This remote control cannot emit the control signals of code "B.")
- When using the remote control, aim the remote control directly at the remote sensor on each component, not on the receiver.

For RX-8030VBK:

- When you press one of the source selection buttons, the operation mode appears on the display window.



| Buttons | Indications |
|-----------------------|--|
| VCR 1 | VCR 1 |
| DVD or DVD MULTI | DVD |
| TV/DBS | TV |
| CONTROL (repeatedly)* | <div style="display: flex; align-items: center; justify-content: center;"> { VCR 1 → TAPE } </div> <div style="display: flex; align-items: center; justify-content: center;"> { CDDSC ← CDR } </div> |

* By pressing CONTROL repeatedly, you can select "VCR 1," "TAPE," "CDR" or "CDDSC" as the source.

When you press one of the buttons listed above, the remote operation mode appears on the operation mode display for about two hours.

VCR

You can always perform the following operations:

VCR 1 \odot/I (for RX-8030VBK) or VCR \odot/I (for RX-7030VBK/RX-7032VSL): Turn on or off a VCR.

For RX-8030VBK: After pressing VCR 1 (or selecting "VCR 1" by pressing CONTROL repeatedly), you can perform the following operations on a VCR:

For RX-7030VBK/RX-7032VSL: After pressing VCR (or VCR CONTROL), you can perform the following operations on a VCR:

- 1 – 9, 0: Select the TV channels on a VCR.
- ▶: Start playing.
- REW: Rewind a tape.
- FF: Fast wind a tape.
- : Stop playing or recording.
- ||: Pause playing. To resume, press ▶.
- REC PAUSE: Enter recording pause by pressing this button. To start recording again, press this button then ▶.
- CH +/-: Change the TV channels on the VCR.

Note:

You can use either VCR 1 (for RX-8030VBK) or VCR (for RX-7030VBK/RX-7032VSL) or the control button (CONTROL for RX-8030VBK or VCR CONTROL for RX-7030VBK/RX-7032VSL) to activate the buttons listed above. If you press one of the source selection buttons, the playing source also changes. On the other hand, pressing the control button does not change the playing source.

DVD player

After pressing DVD or DVD MULTI, you can perform the following operations on a DVD player:

- ▶: Start playing.
- ◀◀: Return to the beginning of the current (or previous) chapter.
- ▶▶: Skip to the beginning of the next chapter.
- : Stop playing.
- ||: Pause playing. To resume, press ▶.

After pressing DVD or DVD MULTI, these buttons can be used for the DVD menu operations.

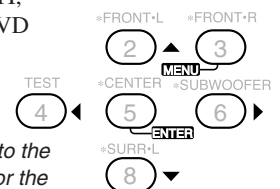

Note:

For detailed menu operations, refer to the instructions supplied with the discs or the DVD player.

TV

You can always perform the following operations:

- TV \odot/I : Turn on or off the TV.
- TV VOL +/-: Adjust the volume.
- TV/VIDEO: Set the input mode (either TV or VIDEO).

After pressing TV/DBS, you can perform the following operations on a TV:

- CH +/-: Change the channels.
- 1 – 9, 0, 100+: Select the channels.
- RETURN: Alternate between the previously selected channel and the current channel.

Operating Other Manufacturers' Video Equipment

This remote control supplied with the receiver can transmit control signals for other manufacturers' TVs, CATV converters, DBS tuners, VCRs and DVD players.

When operating the other manufacturers' components, refer also to the manuals supplied with them.

- After replacing batteries for the remote control, you need to set the manufactures' codes again.

To change the transmittable signals for operating another manufacturer's TV

1. Press and hold TV \odot/I .
2. Press TV/DBS.
For RX-8030VBK: "CALL" appears on the display window of the remote control.
3. Enter a manufacturer's code using buttons 1 – 9, and 0.
See the list on page 49 to find the code.
4. Release TV \odot/I .

The following buttons can be used for operating a TV:

| | |
|-----------------------|--|
| TV \odot/I : | Turn on and off a TV. |
| TV VOL +/-: | Adjust the volume. |
| TV/VIDEO: | Set the input mode (either TV or VIDEO). |

After pressing TV/DBS, you can perform the following operations on a TV:

| | |
|--------------------------|--|
| CH +/-: | Change the channels. |
| 1 – 10/0, 0, 100+ (+10): | Select the channels. The 10/0 button will function as the ENTER button if your TV requires pressing ENTER after selecting a channel number. |

Notes:

- All the functions listed above may not be assigned to the buttons for some TVs.
- If you cannot change the channels of some TVs by pressing 10 keys, press CH +/- for changing the channels.

5. Try to operate your TV by pressing TV \odot/I .

When your TV turns on or off, you have entered the correct code.

If there are more than one code listed for your brand of TV, try each one until the correct one is entered.

To change the transmittable signals for operating a CATV converter or DBS tuner

1. Press and hold CATV/DBS \odot/I .
2. Press CATV/DBS CONTROL.
For RX-8030VBK: "CALL" appears on the display window of the remote control.
3. Enter a manufacturer's code using buttons 1 – 9, and 0.
See the list on page 49 to find the code.
4. Release CATV/DBS \odot/I .

The following buttons can be used for operating a CATV converter and DBS tuner:

CATV/DBS \odot/I : Turn on and off a CATV converter or DBS tuner.

After pressing CATV/DBS CONTROL, you can perform the following operations on a CATV converter or DBS tuner:

| | |
|--------------------------|---|
| CH +/-: | Change the channels. |
| 1 – 10/0, 0, 100+ (+10): | Select the channels. The 10/0 button will function as the ENTER button if your equipment requires pressing ENTER after selecting a channel number. |

5. Try to operate your CATV converter or DBS tuner by pressing CATV/DBS \odot/I .

When your CATV converter or DBS tuner turns on or off, you have entered the correct code.

If there are more than one code listed for your brand of CATV converter or DBS tuner, try each one until the correct one is entered.

Note:

You cannot preset the signals for both the CATV converter and DBS tuner at the same time.

To change the transmittable signals for operating another manufacturer's VCR

1. Press and hold VCR 1 ϕ /I (for RX-8030VBK) or VCR ϕ /I (for RX-7030VBK/RX-7032VSL).
2. Press VCR 1 (for RX-8030VBK) or VCR (for RX-7030VBK/RX-7032VSL).

For RX-8030VBK: "CALL" appears on the display window of the remote control.

3. Enter manufacturer's code using buttons 1 – 9, and 0.

See the list on page 49 to find the code.

4. Release VCR 1 ϕ /I or VCR ϕ /I.

The following buttons can be used for operating a VCR:

VCR 1 ϕ /I: For RX-8030VBK—Turn on and off a VCR.

VCR ϕ /I: For RX-7030VBK/RX-7032VSL—Turn on and off a VCR.

After pressing VCR 1 or VCR, you can perform the following operations on a VCR:

CH +/-: Change the TV channels on a VCR.

1 – 10/0, 0, 100+ (+10):

Select the TV channels.

The 10/0 button will function as the ENTER button if your VCR requires pressing ENTER after selecting a channel number.

- ▶: Start playback.
- REW: Rewind a tape.
- FF: Fast wind a tape.
- : Stop playing or recording.
- II: Pause playing. To resume, press ▶.
- REC PAUSE: Enter recording pause by pressing this button. To start recording again, press this button then ▶.

5. Try to operate your VCR by pressing VCR 1 ϕ /I or VCR ϕ /I.

When your VCR turns on or off, you have entered the correct code.

If there are more than one code listed for your brand of VCR, try each one until the correct one is entered.

To change the transmittable signals for operating another manufacturer's DVD player

1. Press and hold AUDIO ϕ /I.
2. Press DVD.
For RX-8030VBK: "CALL" appears on the display window of the remote control.
3. Enter a manufacturer's code using buttons 1 – 9, and 0.
See the list on page 49 to find the code.
4. Release AUDIO ϕ /I.
After pressing DVD or DVD MULTI, you can perform the following operations on a DVD player:

- ▶: Start playing.
- ◀◀: Return to the beginning of the current (or previous) chapter.
- ▶▶: Skip to the beginning of the next chapter.
- : Stop playing.
- II: Pause playing. To resume, press ▶.

After pressing DVD or DVD MULTI, these buttons can be used for the DVD menu operations.

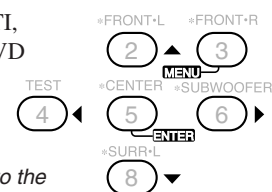

Note:

For detailed menu operations, refer to the instructions supplied with the discs or the DVD player.

5. Try to operate your DVD player by pressing one of the above buttons.

- DO NOT forget to turn on a DVD player before pressing one of the above buttons.

If there are more than one code listed for your brand of DVD, try each one until the correct one is entered.

For TV

| Manufacturer | Codes | Manufacturer | Codes |
|--------------|-------------------------|-----------------|--|
| JVC | 00*, 02, 13, 14, 47, 74 | Quelle | 52, 53, 54, 55, 56, 57, 58, 59, 60, 61, 62, 63, 64, 65, 66, 67 |
| Akai | 01, 02 | RCA/ Proscan | 08, 24, 29, 30, 31, 48 |
| Blaupunkt | 03, 04 | | SABA |
| Fisher | 01, 05 | Samsung | 06, 08, 16, 34, 35, 49 |
| Grundig | 03, 06, 07 | Sanyo | 01, 05 |
| Hitachi | 08, 09, 10, 49 | Schneider | 02, 15, 36 |
| Irradio | 02 | Sharp | 37, 38, 77 |
| ITT/NOKIA | 11, 12 | Sony | 39 |
| Loewe | 06, 15, 16 | Telefunken | 40, 41, 42, 69 |
| Magnavox | 08, 17, 49 | Thomson | 71, 72 |
| Mets | 50, 51, 52, 53 | Toshiba | 37, 43, 44 |
| Mitsubishi | 08, 18, 19, 20 | Zenith | 45, 46 |
| Mivar | 21 | | |
| Nordmende | 22, 23 | | |
| Okano | 15 | | |
| Panasonic | 24, 25, 26, 27, 76 | | |
| Philips | 15, 17, 28, 75 | | |

For VCR

| Manufacturer | Codes |
|---------------|--------------------------------|
| JVC | 00*, 26, 27, 28, 29, 58 |
| Aiwa | 01, 02 |
| Bell & Howell | 03 |
| Blaupunkt | 04, 05 |
| CGM | 06, 07 |
| Emerson | 08, 10, 11, 12, 64, 65 |
| Fisher | 03, 14, 15, 16, 17 |
| Funai | 01 |
| GE | 18, 19, 20 |
| Goldstar | 07 |
| Goodmans | 13, 21 |
| Grundig | 06, 22 |
| Hitachi | 18, 23, 24, 25, 66 |
| Loewe | 07, 21 |
| Magnavox | 04, 19, 24 |
| Mitsubishi | 30, 31, 32, 33, 34, 35 |
| NEC | 26, 27 |
| Nokia | 03, 36 |
| Nordmende | 38 |
| Orion | 09 |
| Panasonic | 19, 24, 39, 40 |
| Philips | 04, 19, 21, 24, 41, 42 |
| Phonola | 21 |
| RCA/Proscan | 04, 18, 19, 23, 24, 43, 44, 45 |
| SABA | 38, 46 |
| Samsung | 45, 47, 59, 61, 62, 63 |
| Sanyo | 03, 48, 49 |
| Sharp | 37, 50 |
| Siemens | 03, 51 |
| Sony | 52, 53, 54 |
| Telefunken | 55, 60 |
| Toshiba | 43, 44 |
| Zenith | 56, 57 |

For DBS tuner

| Manufacturer | Codes |
|--------------|----------------------------|
| JVC | 56*, 57, 67 |
| Amstrad | 43, 44, 45, 46, 47, 48, 49 |
| Blaupunkt | 30 |
| Echostar | 50, 51, 67 |
| Goldstar | 31 |
| Grundig | 32, 33 |
| Hirshmann | 48, 52, 53, 54, 55 |
| Instrument | 68 |
| ITT/NOKIA | 34 |
| Kathrein | 52, 58, 59, 60, 61, 62, 63 |
| NEC | 35, 36 |
| Orbitech | 48 |
| Philips | 37, 38 |
| RCA | 65 |
| Samsung | 39, 40 |
| Schwaiger | 61, 64 |
| Siemens | 41, 42 |
| Sony | 66 |
| Technisat | 48 |

For DVD player

| Manufacturer | Codes |
|--------------|------------|
| JVC | 00*, 02 |
| Denon | 01 |
| Panasonic | 03 |
| Philips | 13 |
| Pioneer | 04, 05, 06 |
| RCA | 07 |
| Samsung | 08 |
| Sony | 09 |
| Toshiba | 10 |
| Yamaha | 11, 12 |

*Initial setting





For CATV converter

| Manufacturer | Codes |
|--------------------|--|
| General Instrument | 06, 07, 08, 09, 10, 11, 12, 13, 14, 29 |
| Hamlin/Regal | 01, 02, 03, 04, 05 |
| Jerrold | 06, 07, 08, 09, 10, 11, 12, 13, 14 |
| Oak | 15, 16, 17 |
| Panasonic | 18, 19, 20 |
| Pioneer | 21, 22 |
| Scientific Atlanta | 23, 24, 25 |
| Tocom | 26 |
| Zenith | 27, 28 |

Manufacturers' codes are subject to change without notice. If they are changed, this remote control cannot operate the equipment.

Troubleshooting

Use this chart to help you solve daily operational problems. If there is any problem you cannot solve, contact your JVC's service center.

| PROBLEM | POSSIBLE CAUSE | SOLUTION |
|---|---|--|
| The display does not light up. | The power cord is not plugged in. | Plug the power cord into an AC outlet. |
| No sound from speakers. | Speaker signal cables are not connected. | Check speaker wiring and reconnect if necessary. (See pages 9 to 11.) |
| | The SPEAKERS ON/OFF 1 and SPEAKERS ON/OFF 2 buttons are not set correctly. | Press SPEAKERS ON/OFF 1 and SPEAKERS ON/OFF 2 correctly. (See page 19.) |
| | An incorrect source is selected. | Select the correct source. |
| | Muting is activated. | Press MUTING to cancel the mute. (See page 22.) |
| | An incorrect input mode (analog or digital) is selected. | Select the correct input mode (analog or digital). (See page 19.) |
| Sound from one speaker only. | Speaker signal cables are not connected properly. | Check speaker wiring and reconnect if necessary. (See pages 9 to 11.) |
| Continuous hiss or buzzing during FM reception. | Incoming signal is too weak. | Connect an outdoor FM antenna or contact your dealer. (See page 8.) |
| | The station is too far away. | Select a new station. |
| | An incorrect antenna is used. | Check with your dealer to be sure you have the correct antenna. |
| Noise is heard during FM/AM reception. | Antennas are not connected properly. | Check connections. (See page 8.) |
| | Ignition noise from automobiles. | Move the antenna farther from automobile traffic. |
| Howling during record playing. | A ground cable from the turntable is not connected to the screw marked (⌘) on the rear. | Connect the cable to the screw marked (⌘) on the rear. |
| | Your turntable is too close to the speakers. | Move the speakers away from the turntable. |
| No sound effect such as Surround mode, DSP mode and Digital Equalization. | Analog Direct is turned on. | Turn off Analog Direct. (See page 21.) |
| | DVD MULTI is selected as the source. | Select the source other than DVD MULTI. (See page 40.) |
| EX/ES (7.1-channel) reproduction cannot be done for Dolby Digital EX or DTS ES software. | Software or setting is not for Dolby Digital EX or DTS ES software. | Play back software bearing the mark  or  . Set "EX/ES" setting to "ON." (See page 37.) |
| "OVERLOAD" starts flashing on the display. | Speakers are overloaded because of high volume. | <ol style="list-style-type: none"> 1. Press  STANDBY/ON on the front panel to turn off the receiver. 2. Stop the playback source. 3. Turn on the receiver again, and adjust the volume. |
| | Speakers are overloaded because of short circuit of speaker terminals. | Press  STANDBY/ON on the front panel to turn off the receiver, then check the speaker wiring. If "OVERLOAD" does not disappear, unplug the AC power cord, then plug it back again. If speaker wiring is not short-circuited, contact your dealer. |
| The STANDBY lamp lights up after turning on the power, and soon the receiver turns off again (into standby mode). | The receiver is overloaded because of a high voltage. | Press  STANDBY/ON on the front panel to turn off the receiver. After unplugging the AC power cord, consult your dealer. |
| Remote control does not work. | There is an obstruction between the remote sensor on the receiver and the remote control. | Remove the obstruction. |
| | Batteries are weak. | Replace batteries. (See page 8.) |
| Remote control does not work as you intend. | An incorrect remote control operation mode is selected. | Select the correct remote control operation mode. (See pages 44 to 49.) |

Specifications

RX-8030VBK

Amplifier

Output Power

At Stereo operation

Front ch: **130 W per channel, min. RMS, driven into 8 Ω , 20 Hz to 20 kHz, with no more than 0.08% total harmonic distortion.**

At Surround operation:

Front ch: 130 W per channel, min. RMS, driven into 8 Ω at 1 kHz, with no more than 0.8% total harmonic distortion.

Center ch: 130 W, min. RMS, driven into 8 Ω at 1 kHz, with no more than 0.8% total harmonic distortion.

Surround ch: 130 W per channel, min. RMS, driven into 8 Ω at 1 kHz, with no more than 0.8% total harmonic distortion.

Surround Back ch: 130 W, min. RMS, driven into 8 Ω at 1 kHz, with no more than 0.8% total harmonic distortion.

Audio

Audio Input Sensitivity/Impedance (1 kHz)

PHONO IN (MM): 2.5 mV/47 k Ω

DVD IN, VCR 1 IN, VCR 2 IN, TV SOUND/DBS IN, VIDEO IN: 200 mV/47 k Ω

CD IN, CDR IN, TAPE/MD IN: 200 mV/47 k Ω

Audio Input (DIGITAL IN)*

Coaxial: DIGITAL 1 (DVD): 0.5 V(p-p)/75 Ω

Optical: DIGITAL 2 (CD), DIGITAL 3 (TV), DIGITAL 4 (CDR): -21 dBm to -15 dBm (660 nm \pm 30 nm)

* Corresponding to Linear PCM, Dolby Digital, and DTS Digital Surround (with sampling frequency — 32 kHz, 44.1 kHz, 48 kHz).

Audio Output Level: PRE OUT: 1 V

Recording Output Level: VCR 1 OUT, VCR 2 OUT, CDR OUT, TAPE/MD OUT: 200 mV

Digital output: Optical: DIGITAL OUTPUT
Signal wave length: 660 nm
Output level: -21 dBm to -15 dBm

Signal-to-Noise Ratio ('66 IHF/'78 IHF)
PHONO IN: 70 dB/78 dB (at REC OUT)

DVD IN, VCR 1 IN, VCR 2 IN, TV SOUND/DBS IN, VIDEO: 87 dB/80 dB

CD IN, CDR IN, TAPE/MD IN: 87 dB/80 dB

Frequency Response (8 Ω)
PHONO IN: 20 Hz to 20 kHz (\pm 1 dB)

DVD IN, VCR 1 IN, VCR 2 IN, TV SOUND/DBS IN, VIDEO: 20 Hz to 100 kHz (+1 dB, -3 dB)

CD IN, CDR IN, TAPE/MD IN: 20 Hz to 100 kHz (+1 dB, -3 dB)

RIAA Phono Equalization: \pm 1.0 dB (20 Hz to 20 kHz)

Equalization (5 bands): 63 Hz, 250 Hz, 1 kHz, 4 kHz, 16 kHz (\pm 8 dB)

Bass boost: +6 dB \pm 1.0 dB at 100 Hz

Video

Video Input Sensitivity/Impedance

Composite video:

DVD IN, VCR 1 IN, VCR 2 IN, TV SOUND/DBS IN, VIDEO: 1 V(p-p)/75 Ω

S-video:

DVD IN, VCR 1 IN, VCR 2 IN, TV SOUND/DBS IN, VIDEO:
(Y: luminance): 1 V(p-p)/75 Ω
(C: chrominance, burst): 0.286 V(p-p)/75 Ω

Component video: DVD IN, DBS IN:

(Y: luminance): 1 V(p-p)/75 Ω
(P_B/P_R): 0.7 V(p-p)/75 Ω

Video Output Level

Composite video:

VCR 1 OUT, VCR 2 OUT, MONITOR OUT 1 V(p-p)/75 Ω

S-video: VCR 1 OUT, VCR 2 OUT, MONITOR OUT

(Y: luminance): 1 V(p-p)/75 Ω
(C: chrominance, burst): 0.286 V(p-p)/75 Ω

Component video: MONITOR OUT:

(Y: luminance): 1 V(p-p)/75 Ω
(P_B/P_R): 0.7 V(p-p)/75 Ω

Synchronization:

Signal-to-Noise Ratio: Negative 45 dB

FM tuner (IHF)

Tuning Range: 87.5 MHz to 108.0 MHz

Usable Sensitivity: Monaural: 12.8 dBf (1.2 μ V/75 Ω)

50 dB Quieting Sensitivity: Monaural: 16.0 dBf (1.7 μ V/75 Ω)

Stereo: 37.5 dBf (20.5 μ V/75 Ω)

Stereo Separation at REC OUT: 35 dB at 1 kHz

AM tuner

Tuning Range: 530 kHz to 1 710 kHz

General

Power Requirements: AC 120V \sim , 60 Hz

Power Consumption: 320 W/440 VA (at operation)
2 W (in standby mode)

Dimensions (W x H x D): 435 mm x 157 mm x 425 mm
(17 ³/₁₆ in. x 6 ³/₁₆ in. x 16 ³/₄ in.)

Mass: 12.2 kg (27.0 lbs)

Designs & specifications are subject to change without notice

RX-7030VBK/RX-7032VSL

Amplifier

Output Power

At Stereo operation

Front ch: **110 W per channel, min. RMS, driven into 8 Ω, 20 Hz to 20 kHz, with no more than 0.08% total harmonic distortion.**

At Surround operation:

Front ch: 110 W per channel, min. RMS, driven into 8 Ω at 1 kHz, with no more than 0.8% total harmonic distortion.

Center ch: 110 W, min. RMS, driven into 8 Ω at 1 kHz, with no more than 0.8% total harmonic distortion.

Surround ch: 110 W per channel, min. RMS, driven into 8 Ω at 1 kHz, with no more than 0.8% total harmonic distortion.

Surround Back ch:

110 W, min. RMS, driven into 8 Ω at 1 kHz, with no more than 0.8% total harmonic distortion.

Audio

Audio Input Sensitivity/Impedance (1 kHz)

DVD IN, VCR IN, TV SOUND/DBS IN: 200 mV/47 kΩ

CD IN, TAPE/CDR IN: 200 mV/47 kΩ

Audio Input (DIGITAL IN)*

Coaxial: DIGITAL 1 (DVD): 0.5 V(p-p)/75 Ω

Optical: DIGITAL 2 (CD), DIGITAL 3 (TV), DIGITAL 4 (CDR):
-21 dBm to -15 dBm (660 nm ±30 nm)

* Corresponding to Linear PCM, Dolby Digital, and DTS Digital

Surround (with sampling frequency — 32 kHz, 44.1 kHz, 48 kHz).

Audio Output Level: SUBWOOFER OUT: 1 V

Recording Output Level: VCR OUT, TAPE/CDR OUT: 200 mV

Digital output: Optical: DIGITAL OUT

Signal wave length: 660 nm

Output level: -21 dBm to -15 dBm

Signal-to-Noise Ratio (*66 IHF/*78 IHF)

DVD IN, VCR IN, TV SOUND/DBS IN: 87 dB/80 dB

CD IN, TAPE/CDR IN: 87 dB/80 dB

Frequency Response (8 Ω)

DVD IN, VCR IN, TV SOUND/DBS IN:

20 Hz to 100 kHz (+1 dB, -3 dB)

CD IN, TAPE/CDR IN: 20 Hz to 100 kHz (+1 dB, -3 dB)

Equalization (5 bands):

63 Hz, 250 Hz, 1 kHz, 4 kHz, 16 kHz (±8 dB)

Bass boost:

+6 dB ±1.0 dB at 100 Hz

Video

Video Input Sensitivity/Impedance

Composite video: DVD IN, VCR IN, TV SOUND/DBS IN:

1 V(p-p)/75 Ω

S-video: DVD IN, VCR IN, TV SOUND/DBS IN:

(Y: luminance): 1 V(p-p)/75 Ω

(C: chrominance, burst): 0.286 V(p-p)/75 Ω

Component video: DVD IN, DBS IN:

(Y: luminance): 1 V(p-p)/75 Ω

(Pb/Pr): 0.7 V(p-p)/75 Ω

Video Output Level

Composite video: VCR OUT, MONITOR OUT 1 V(p-p)/75 Ω

S-video: VCR OUT, MONITOR OUT

(Y: luminance): 1 V(p-p)/75 Ω

(C: chrominance, burst): 0.286 V(p-p)/75 Ω

Component video: MONITOR OUT

(Y: luminance): 1 V(p-p)/75 Ω

(Pb/Pr): 0.7 V(p-p)/75 Ω

Synchronization:

Negative

Signal-to-Noise Ratio:

45 dB

FM tuner (IHF)

Tuning Range: 87.5 MHz to 108.0 MHz

Usable Sensitivity: Monaural: 12.8 dBf (1.2 μV/75 Ω)

50 dB Quietening Sensitivity: Monaural: 16.0 dBf (1.7 μV/75 Ω)

Stereo: 37.5 dBf (20.5 μV/75 Ω)

Stereo Separation at REC OUT: 35 dB at 1 kHz

AM tuner

Tuning Range: 530 kHz to 1 710 kHz

General

Power Requirements: AC 120V~, 60 Hz

Power Consumption: 320 W/440 VA (at operation)

2 W (in standby mode)

Dimensions (W x H x D): 435 mm x 157 mm x 425 mm

(17 ³/₁₆ in. x 6 ³/₁₆ in. x 16 ³/₄ in.)

Mass: 12.1 kg (26.7 lbs)

Designs & specifications are subject to change without notice



LIMITED WARRANTY

AUDIO-2

JVC COMPANY OF AMERICA warrants this product and all parts thereof, except as set forth below ONLY TO THE ORIGINAL PURCHASER AT RETAIL to be FREE FROM DEFECTIVE MATERIALS AND WORKMANSHIP from the date of original retail purchase for the period as shown below. ("The Warranty Period")

| | | | |
|-------|--------------|-------|--------------|
| PARTS | 2 YRS | LABOR | 2 YRS |
|-------|--------------|-------|--------------|

THIS LIMITED WARRANTY IS VALID ONLY IN THE FIFTY (50) UNITED STATES, THE DISTRICT OF COLUMBIA AND IN COMMONWEALTH OF PUERTO RICO.

WHAT WE WILL DO:

If this product is found to be defective, JVC will repair or replace defective parts at no charge to the original owner. Such repair and replacement services shall be rendered by JVC during normal business hours at JVC authorized service centers. Parts used for replacement are warranted only for the remainder of the Warranty Period. All products and parts thereof may be brought to a JVC authorized service center on a carry-in basis except for Television sets having a screen size 25 inches and above which are covered on an in-home basis.

WHAT YOU MUST DO FOR WARRANTY SERVICE:

Return your product to a JVC authorized service center with a copy of your bill of sale. For your nearest JVC authorized service center, please call toll free: (800) 537-5722.

If service is not available locally, box the product carefully, preferably in the original carton, and ship, insured, with a copy of your bill of sale plus a letter of explanation of the problem to the nearest JVC Factory Service Center, the name and location of which will be given to you by the toll-free number.

If you have any questions concerning your JVC Product, please contact our Customer Relations Department.

WHAT IS NOT COVERED:

This limited warranty provided by JVC does not cover:

1. Products which have been subject to abuse, accident, alteration, modification, tampering, negligence, misuse, faulty installation, lack of reasonable care, or if repaired or serviced by anyone other than a service facility authorized by JVC to render such service, or if affixed to any attachment not provided with the products, or if the model number or serial number has been altered, tampered with, defaced or removed;
2. Initial installation and installation and removal for repair;
3. Operational adjustments covered in the Owner's Manual, normal maintenance, video and audio head cleaning;
4. Damage that occurs in shipment, due to act of God, and cosmetic damage;
5. Signal reception problems and failures due to line power surge;
6. Video Pick-up Tubes/CCD Image Sensor, Cartridge, Stylus (Needle) are covered for 90 days from the date of purchase;
7. Batteries (except that Rechargeable Batteries are covered for 90 days from the date of purchase);

There are no express warranties except as listed above.

THE DURATION OF ANY IMPLIED WARRANTIES, INCLUDING THE IMPLIED WARRANTY OF MERCHANTABILITY, IS LIMITED TO THE DURATION OF THE EXPRESS WARRANTY HEREIN.

JVC SHALL NOT BE LIABLE FOR THE LOSS OF USE OF THE PRODUCT, INCONVENIENCE, LOSS OR ANY OTHER DAMAGES, WHETHER DIRECT, INCIDENTAL OR CONSEQUENTIAL (INCLUDING, WITHOUT LIMITATION, DAMAGE TO TAPES, RECORDS OR DISCS) RESULTING FROM THE USE OF THIS PRODUCT, OR ARISING OUT OF ANY BREACH OF THIS WARRANTY. ALL EXPRESS AND IMPLIED WARRANTIES, INCLUDING THE WARRANTIES OF MERCHANTABILITY AND FITNESS FOR PARTICULAR PURPOSE, ARE LIMITED TO THE WARRANTY PERIOD SET FORTH ABOVE.

Some states do not allow the exclusion of incidental or consequential damages or limitations on how long an implied warranty lasts, so these limitations or exclusions may not apply to you. This warranty gives you specific legal rights and you may also have other rights which vary from state to state.

JVC COMPANY OF AMERICA
DIVISION OF JVC AMERICAS CORP.

1700 Valley Road
Wayne, NJ 07470

REFURBISHED PRODUCTS CARRY A SEPARATE WARRANTY, THIS WARRANTY DOES NOT APPLY. FOR DETAILS OF REFURBISHED PRODUCT WARRANTY, PLEASE REFER TO THE REFURBISHED PRODUCT WARRANTY INFORMATION PACKAGED WITH EACH REFURBISHED PRODUCT.

For customer use:

Enter below the Model No. which is located either on the rear, bottom or side of the cabinet. Retain this information for future reference.

Model No. : _____

Serial No. : _____

Purchase data : _____

Name of dealer : _____

Authorized Service Centers

QUALITY **JVC**[®] SERVICE
HOW TO LOCATE YOUR JVC SERVICE CENTER
TOLL FREE: 1 (800) 537-5722
<http://www.jvc.com>

Dear Customer,

In order to receive the most satisfaction from your purchase, please read the instruction booklet before operating the unit. In the event that repairs are necessary, please call 1 (800)537-5722 for your nearest authorized servicer or visit our website at www.JVC.com

Remember to retain your Bill of Sale for Warranty Service.

Do not service the television yourself

Caution

To prevent electrical shock, do not open the cabinet. There are no user serviceable parts inside. Please refer to qualified service personnel for repairs.

Accessories

To purchase accessories for your JVC product, please call toll free: 1 (800)882-2345 or on the web at www.JVC.com

RX-8030VBK
RX-7030VBK/RX-7032VSL

AUDIO/VIDEO CONTROL RECEIVER

JVC
VICTOR COMPANY OF JAPAN, LIMITED

JVC

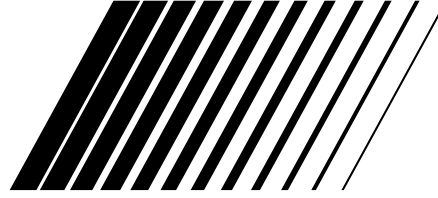

English

Français

AUDIO/VIDEO CONTROL RECEIVER

AMPLI/TUNER DE COMMANDE AUDIO/VIDEO

RX-8030VBK RX-7030VBK

AV/COMPU LINK

COMPU LINK
/// Remote ///



(For RX-8030VBK)



(For RX-8030VBK)

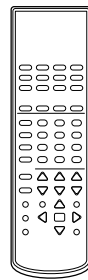
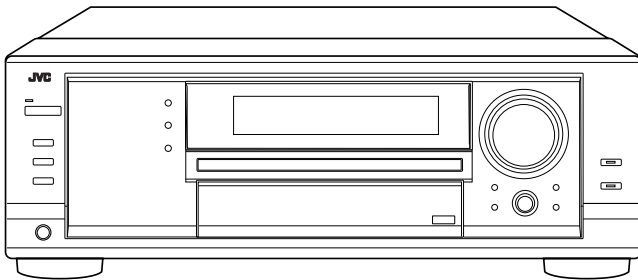

INSTRUCTIONS

MANUEL D'INSTRUCTIONS

For Customer Use:

Enter below the Model No. and Serial No. which are located either on the rear, bottom or side of the cabinet. Retain this information for future reference.

Model No. _____

Serial No. _____

Warnings, Cautions and Others/ Mises en garde, précautions et indications diverses

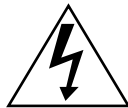

The lightning flash with arrowhead symbol, within an equilateral triangle is intended to alert the user to the presence of uninsulated "dangerous voltage" within the product's enclosure that may be of sufficient magnitude to constitute a risk of electric shock to persons.



The exclamation point within an equilateral triangle is intended to alert the user to the presence of important operating and maintenance (servicing) instructions in the literature accompanying the appliance.

WARNING: TO REDUCE THE RISK OF FIRE OR ELECTRIC SHOCK, DO NOT EXPOSE THIS APPLIANCE TO RAIN OR MOISTURE.

CAUTION

To reduce the risk of electrical shocks, fire, etc.:

1. Do not remove screws, covers or cabinet.
2. Do not expose this appliance to rain or moisture.

ATTENTION

Afin d'éviter tout risque d'électrocution, d'incendie, etc.:

1. Ne pas enlever les vis ni les panneaux et ne pas ouvrir le coffret de l'appareil.
2. Ne pas exposer l'appareil à la pluie ni à l'humidité.

Caution — ϕ /I STANDBY/ON button!

Disconnect the mains plug to shut the power off completely. The ϕ /I STANDBY/ON button in any position does not disconnect the mains line. The power can be remote controlled.

Attention — Commutateur ϕ /I STANDBY/ON!

Déconnecter la fiche de secteur pour couper complètement le courant. Le commutateur ϕ /I STANDBY/ON ne coupe jamais complètement la ligne de secteur, quelle que soit sa position. Le courant peut être télécommandé.

Note to CATV system installer:

This reminder is provided to call the CATV system installer's attention to Section 820-40 of the NEC which provides guidelines for proper grounding and, in particular, specifies that the cable ground shall be connected to the grounding system of the building, as close to the point of cable entry as practical.

For U.S.A

This equipment has been tested and found to comply with the limits for a Class B digital device, pursuant to part 15 of the FCC Rules. These limits are designed to provide reasonable protection against harmful interference in a residential installation.

This equipment generates, uses and can radiate radio frequency energy and, if not installed and used in accordance with the instructions, may cause harmful interference to radio communications. However, there is no guarantee that interference will not occur in a particular installation. If this equipment does cause harmful interference to radio or television reception, which can be determined by turning the equipment off and on, the user is encouraged to try to correct the interference by one or more of the following measures:

Reorient or relocate the receiving antenna.

Increase the separation between the equipment and receiver.

Connect the equipment into an outlet on a circuit different from that to which the receiver is connected.

Consult the dealer or an experienced radio/TV technician for help.

Changes or modifications not expressly approved by the manufacturer for compliance could void the user's authority to operate the equipment.

For Canada/pour Le Canada

THIS DIGITAL APPARATUS DOES NOT EXCEED THE CLASS B LIMITS FOR RADIO NOISE EMISSIONS FROM DIGITAL APPARATUS AS SET OUT IN THE INTERFERENCE-CAUSING EQUIPMENT STANDARD ENTITLED "DIGITAL APPARATUS," ICES-003 OF THE DEPARTMENT OF COMMUNICATIONS.
CET APPAREIL NUMERIQUE RESPECTE LES LIMITES DE BRUITS RADIOELECTRIQUES APPLICABLES AUX APPAREILS NUMERIQUES DE CLASSE B PRESCRITES DANS LA NORME SUR LE MATERIEL BROUILLEUR; "APPAREILS NUMERIQUES", NMB-003 EDICTEE PAR LE MINISTRE DES COMMUNICATIONS.

For Canada/pour le Canada

CAUTION: TO PREVENT ELECTRIC SHOCK, MATCH WIDE BLADE OF PLUG TO WIDE SLOT, FULLY INSERT

ATTENTION: POUR EVITER LES CHOCS ELECTRIQUES, INTRODUIRE LA LAME LA PLUS LARGE DE LA FICHE DANS LA BORNE CORRESPONDANTE DE LA PRISE ET POUSSER JUSQU'AU FOND

Caution: Proper Ventilation

To avoid risk of electric shock and fire and to protect from damage.

Locate the apparatus as follows:

- Front: No obstructions open spacing.
 - Sides: No obstructions in 10 cm from the sides.
 - Top: No obstructions in 10 cm from the top.
 - Back: No obstructions in 15 cm from the back
 - Bottom: No obstructions, place on the level surface.
- In addition, maintain the best possible air circulation as illustrated.

Attention: Ventilation Correcte

Pour éviter les chocs électriques, l'incendie et tout autre dégât. Disposer l'appareil en tenant compte des impératifs suivants

- Avant: Rien ne doit gêner le dégagement
- Flancs: Laisser 10 cm de dégagement latéral
- Dessus: Laisser 10 cm de dégagement supérieur
- Arrière: Laisser 15 cm de dégagement arrière
- Dessous: Rien ne doit obstruer par dessous; poser l'appareil sur une surface plate.

Veiller également à ce que l'air circule le mieux possible comme illustré.

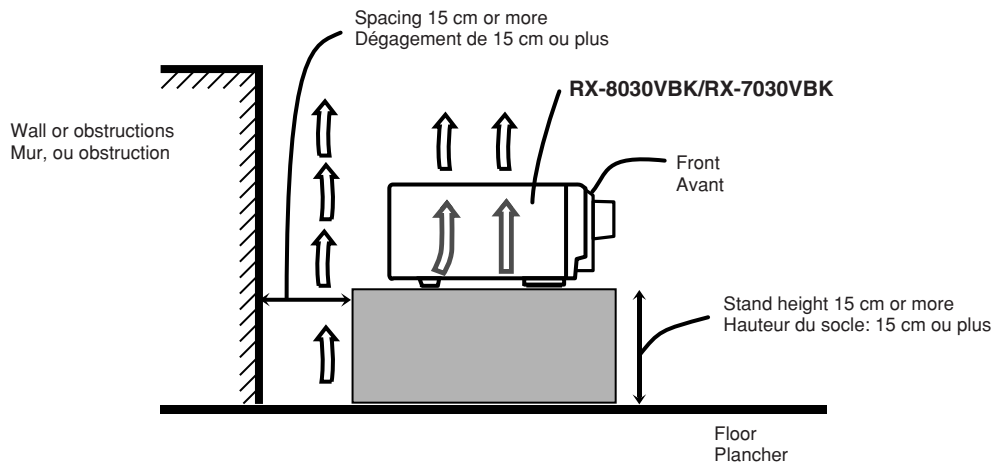

| | | | |
|--|-----------|--|-----------|
| Introduction | 2 | Basic Settings | 25 |
| Features | 2 | Setting the Speakers Configuration | 25 |
| Precautions | 2 | Basic Setting Items | 26 |
| Parts Identification | 3 | Basic Procedure | 27 |
| Remote Control | 3 | Setting the Speakers | 27 |
| Front Panel | 4 | Setting the Speaker Distance | 28 |
| Rear Panel | 6 | Setting the Bass Sounds | 28 |
| Getting Started | 8 | Selecting main or sub channel—DUAL MONO | 29 |
| Before Installation | 8 | Setting the Digital Input Terminals | 29 |
| Checking the Supplied Accessories | 8 | Setting the Component Video Input | 30 |
| Putting Batteries in the Remote Control | 8 | Memorizing the Volume Level for Each Source | 30 |
| Connecting the FM and AM Antennas | 8 | Adjusting Sound | 31 |
| Connecting the Speakers | 9 | Basic Setting Items | 31 |
| Connecting Audio/Video Components | 11 | Basic Procedure | 31 |
| ■ Analog Connections | 11 | Adjusting the Equalization Patterns | 32 |
| ■ Digital Connections | 16 | Adjusting the Speaker Output Levels | 32 |
| Connecting the Power Cord | 16 | Adjusting the Sound Parameters for the Surround and DSP modes | 33 |
| Basic Operations | 17 | Using the Surround Modes | 34 |
| Daily Operational Procedure | 17 | Reproducing Theater Ambience | 34 |
| Turning On the Power | 17 | Introducing the Surround Modes | 34 |
| Selecting the Source to Play | 17 | Surround Modes Applicable to the Various Software | 36 |
| Adjusting the Volume | 18 | Activating the Surround Modes | 37 |
| Selecting the Front Speakers | 19 | ■ Activating the EX/ES setting | 37 |
| Activating and Adjusting the Subwoofer Sound | 19 | ■ Activating the Surrounding modes | 37 |
| Selecting the Analog or Digital Input Mode | 19 | Using the DSP Modes | 38 |
| Setting the Dynamic Range | 20 | Reproducing the Sound Field | 38 |
| Attenuating the Input Signal | 20 | Introducing the DSP Modes | 38 |
| Turning Analog Direct On and Off | 21 | Activating the DSP Modes | 39 |
| Making Sounds Natural | 21 | Using the DVD MULTI Playback Mode | 40 |
| Changing the Source Name | 21 | Activating the DVD MULTI Playback Mode | 40 |
| Reinforcing the Bass | 22 | COMPU LINK Remote Control System | 41 |
| Muting the Sound | 22 | AV COMPU LINK Remote Control System ... | 42 |
| Changing the Display Brightness | 22 | Operating JVC's Audio/Video Components ... | 44 |
| Using the Sleep Timer | 22 | Operating Audio Components | 44 |
| Receiving Radio Broadcasts | 23 | Operating Video Components | 46 |
| Tuning in to Stations Manually | 23 | Operating Other Manufacturers' Video Equipment | 47 |
| Using Preset Tuning | 23 | Troubleshooting | 50 |
| Selecting the FM Reception Mode | 24 | Specifications | 51 |



This mark indicates that **ONLY** the remote control **CAN** be used for the operation explained.



Features with this mark are provided only for RX-8030VBK.



This mark indicates that the remote control **CANNOT** be used for the operation explained. Use the buttons on the front panel.



Features with this mark are provided only for RX-7030VBK.

Introduction

We would like to thank you for purchasing one of our JVC products.
Before operating this unit, read this manual carefully and thoroughly to obtain the best possible performance from your unit, and retain this manual for future reference.

Features

CC (Compensative Compression) converter —ONLY for RX-8030VBK

CC Converter eliminates jitter and ripples, achieving a drastic reduction in digital distortion by processing the digital music data in 24 bit—quantization and by expanding the sampling frequency to 128 kHz (for fs 32 kHz signals)/176.4 kHz (for fs 44.1 kHz signals)/192 kHz (for fs 48 kHz signals). By using the CC Converter, you can obtain a natural sound field from any source. (See page 21 for details.)

K2 technology—ONLY for RX-8030VBK

K2 technology has been designed to enable natural audio reproduction, achieving a drastic reduction in digital distortion and creating original sound ambience with high precision.

Compatible with various audio formats including DTS 96/24

RX-8030VBK and RX-7030VBK allow you to enjoy a newly introduced audio format such as Dolby Digital EX, Dolby Pro Logic II, DTS-ES, DTS Neo:6, and DTS 96/24.

- This unit is also compatible with Dual Mono signals recorded in Dolby Digital and DTS discs.

DAP (Digital Acoustic Processor)

Sound field simulation technology allows precise ambience recreation of existing theaters and halls. Thanks to the high-performance DSP (Digital Signal Processor) and high-capacity memory, you can enjoy multi-channel surround sound by playing 2-channel or multi-channel software according to the speaker setting.

Multi-channel headphone virtual surround sound—3D HEADPHONE Mode

The built-in headphone virtual surround system is compatible with Multi-channel software like Dolby Digital, DTS Surround, etc. Thanks to the new signal processing algorithms used by the high-performance DSP, you can enjoy a natural surround sound through the headphones.

COMPU LINK/AV COMPU LINK remote control systems

These COMPU LINK remote control systems allow you to operate other JVC's audio/video components from this receiver.

Precautions

Power sources

- When unplugging the receiver from the wall outlet, always pull the plug, not the AC power cord.
- Do not handle the AC power cord with wet hands.
- If you are not going to operate the receiver for an extended period of time, unplug the AC power cord from the wall outlet.

Ventilation

High power amplifiers built in this receiver will generate heat inside the cabinet. For safety, observe the following carefully.

- Make sure there is good ventilation around the receiver. Poor ventilation could overheat and damage the receiver.
- Do not block the ventilation openings or holes. (If the ventilation openings or holes are blocked by a newspaper or cloth, etc., the heat may not be able to get out.)

Others

- Should any metallic object or liquid fall onto the unit, unplug the unit and consult your dealer before operating any further.
- Do not expose this apparatus to rain, moisture, dripping or splashing and that no objects filled with liquids, such as vases shall be placed on the apparatus.
- Do not disassemble the unit since there are no user serviceable parts inside.

If anything goes wrong, unplug the AC power cord and consult your JVC dealer.

Remote Control

RX-8030VBK

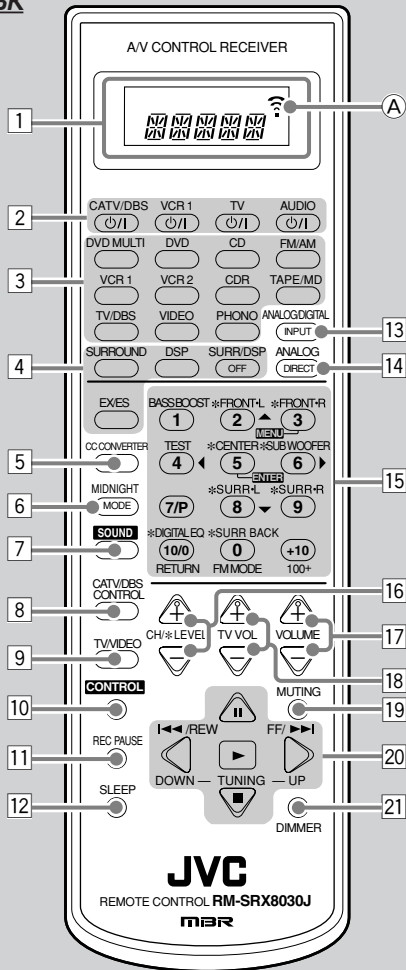

RX-7030VBK

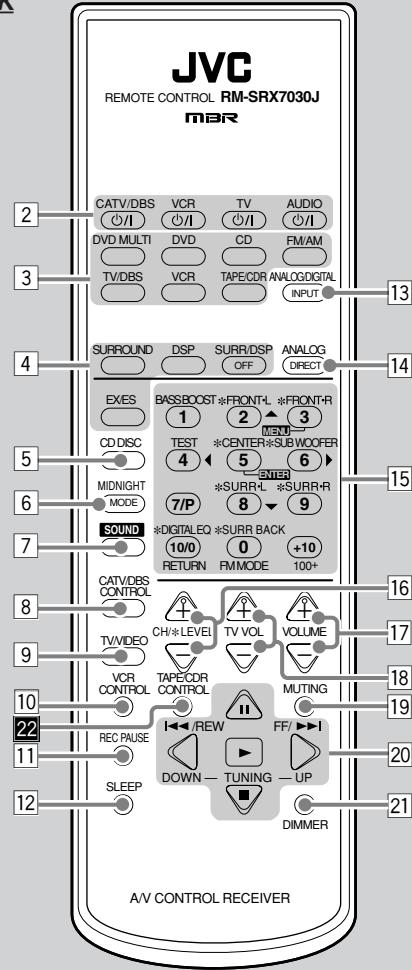

- 1 **Only for RX-8030VBK:** Display window
 - When the remote operation mode changes, it is shown on this display.
 - Signal transmission indicator (A) lights up when transmitting signals.
- 2 ϕ/I buttons (17, 46 – 48)
 - **For RX-8030VBK:** CATV/DBS ϕ/I , VCR 1 ϕ/I , TV ϕ/I , AUDIO ϕ/I
 - **For RX-7030VBK:** CATV/DBS ϕ/I , VCR ϕ/I , TV ϕ/I , AUDIO ϕ/I
- 3 Source selection buttons (17, 18, 19, 23, 24, 37, 40)
 - **For RX-8030VBK:** DVD MULTI, DVD, CD*, FM/AM*, VCR 1, VCR 2, CDR*, TAPE/MD*, TV/DBS, VIDEO, PHONO*
 - **For RX-7030VBK:** DVD MULTI, DVD, CD*, FM/AM*, TV/DBS, VCR, TAPE/CDR*
 - * When you press one on these source selection buttons on the remote control, the receiver automatically turns on.
- 4 SURROUND button (37)
 - DSP button (39)
 - SURR (surround)/DSP OFF button (37, 39)
 - EX/ES button (37)
- 5 • **For RX-8030VBK:** CC CONVERTER button (21)
 - **For RX-7030VBK:** CD DISC button (45)
- 6 MIDNIGHT MODE button (20)
- 7 SOUND button (22, 32, 33)
- 8 CATV/DBS CONTROL button (47)
- 9 TV/VIDEO button (46, 47)
- 10 • **For RX-8030VBK:** CONTROL button (44 – 46)
 - **For RX-7030VBK:** VCR CONTROL button (46)
- 11 REC PAUSE button (45, 46, 48)
- 12 SLEEP button (22)
- 13 ANALOG/DIGITAL INPUT button (20)
- 14 ANALOG DIRECT button (21)
 - 10 keys for operating the tuner (24)
 - 10 keys for adjusting sound (32, 33)
 - 10 keys for operating audio/video components (44 – 48)
- 15 • 10 keys for operating the tuner (24)
 - 10 keys for adjusting sound (32, 33)
 - 10 keys for operating audio/video components (44 – 48)
- 16 • CH (channel) +/- buttons (46 – 48)
 - *LEVEL +/- buttons (32, 33, 44)
 - The LEVEL +/- buttons function only after pressing SOUND then 10 keys which are marked with an asterisk (*) on the remote control.*
- 17 VOLUME +/- buttons (18)
- 18 TV VOL (volume) +/- buttons (46, 47)
- 19 MUTE button (22)
- 20 • TUNING UP/DOWN buttons (23)
 - Operating buttons for audio/video components (44 – 46, 48)
 - ▶, ■, ■, I◀◀/REW, FF/▶▶
- 21 DIMMER button (22)
- 22 **Only for RX-7030VBK:** TAPE/CDR CONTROL button (45)

Front Panel

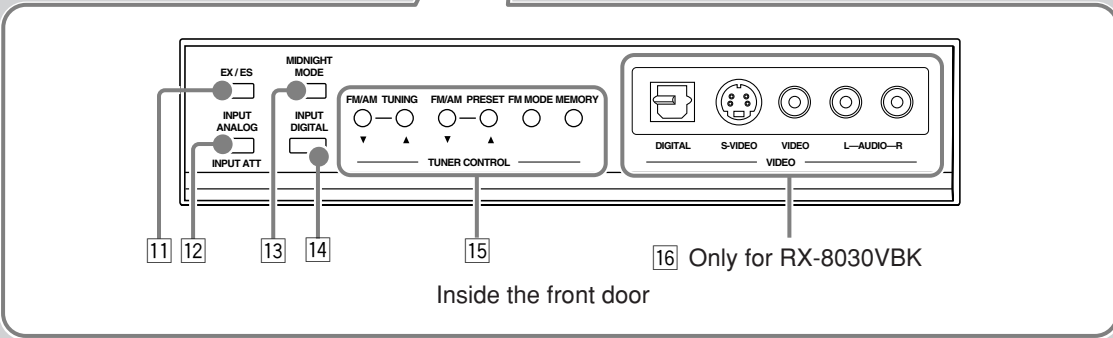
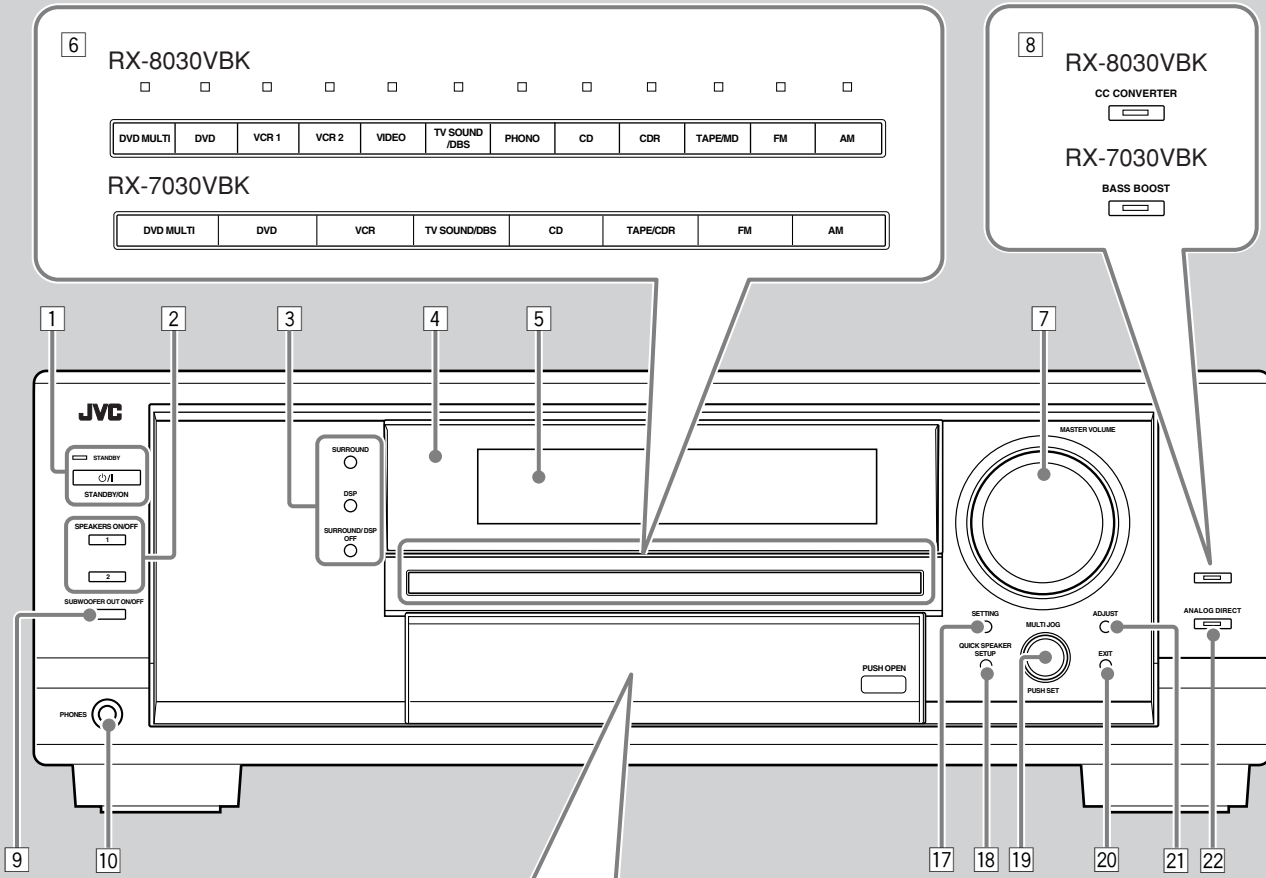

How to open the front door

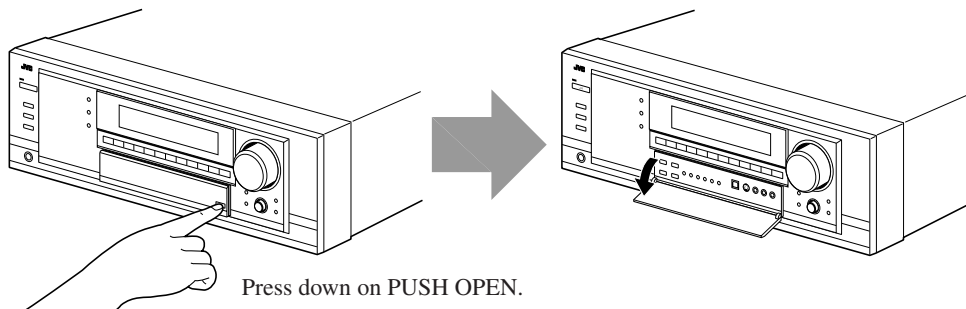

Front Panel

- 1 \mathcal{O} /I STANDBY/ON button and STANDBY lamp (17)
- 2 • SPEAKERS ON/OFF 1 button (19)
- SPEAKERS ON/OFF 2 button (19)
- 3 • SURROUND button (37)
- DSP button (39)
- SURROUND/DSP OFF button (37, 39)
- 4 Remote sensor
- 5 Display window (17)
- 6 • **For RX-8030VBK:** Source selection buttons and lamps (17, 18, 19, 21, 23, 24, 37, 40)
DVD MULTI, DVD, VCR 1, VCR 2, VIDEO,
TV SOUND/DBS, PHONO, CD, CDR, TAPE/MD, FM, AM
(The lamp above the button for selected source lights up.)
- **For RX-7030VBK:** Source selection buttons (17, 18, 19, 21, 23, 24, 37, 40)
DVD MULTI, DVD, VCR , TV SOUND/DBS, CD,
TAPE/CDR, FM, AM
- 7 MASTER VOLUME control (18)
- 8 • **For RX-8030VBK:** CC CONVERTER button and lamp (21)
- **For RX-7030VBK:** BASS BOOST button and lamp (22)
- 9 SUBWOOFER OUT ON/OFF button (19)
- 10 PHONES jack (19)
- 11 EX/ES button (37)
- 12 • INPUT ANALOG button (20)
- INPUT ATT button (20)
- 13 MIDNIGHT MODE button (20)
- 14 INPUT DIGITAL button (20)
- 15 TUNER CONTROL buttons
- FM/AM TUNING \blacktriangle / \blacktriangledown buttons (23)
- FM/AM PRESET \blacktriangle / \blacktriangledown buttons (23, 24)
- FM MODE button (24)
- MEMORY button (23)
- 16 **Only for RX-8030VBK:** VIDEO input jacks (13)
DIGITAL optical terminal, S-VIDEO jack, VIDEO jack,
AUDIO—L/R jacks
- 17 SETTING button (27)
- 18 QUICK SPEAKER SETUP button (25)
- 19 • MULTI JOG control (25, 27, 31)
- PUSH SET button (25, 27, 31)
- 20 EXIT button (27, 31)
- 21 ADJUST button (31)
- 22 ANALOG DIRECT button and lamp (21)

Display Window

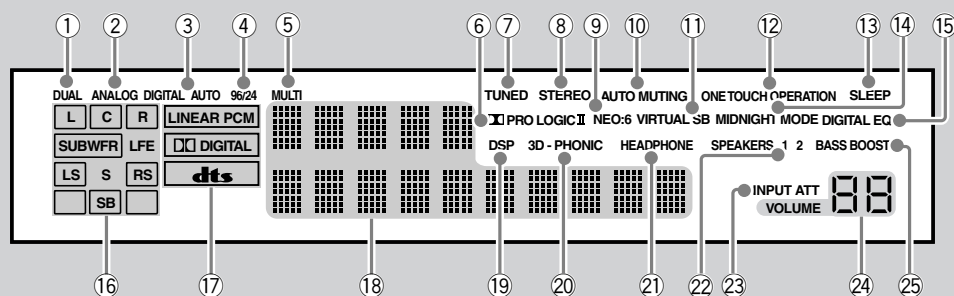

Display Window

- 1 DUAL indicator (35)
- 2 ANALOG indicator (20)
- 3 DIGITAL AUTO indicator (20)
- 4 96/24 indicator (35)
- 5 MULTI indicator (40)
- 6 • \square PRO LOGIC indicator (34)
- \square PRO LOGIC II indicator (35)
- 7 TUNED indicator (23)
- 8 STEREO indicator (23, 24)
- 9 NEO:6 indicator (35)
- 10 AUTO MUTING indicator (24)
- 11 VIRTUAL SB (Surround Back) indicator (34, 35)
- 12 ONE TOUCH OPERATION indicator (30)
- 13 SLEEP indicator (22)
- 14 MIDNIGHT MODE indicator (20)
- 15 DIGITAL EQ (equalization) indicator (32)
- 16 Speaker and signal indicators (18)
- 17 Digital signal format indicators (20)
- 18 Main Display (17)
- 19 DSP indicator (19, 38)
- 20 3D-PHONIC indicator (38)
- 21 HEADPHONE indicator (19, 38)
- 22 SPEAKERS 1/2 indicators (19)
- 23 INPUT ATT (attenuator) indicator (20)
- 24 VOLUME level indicator (17, 22)
- 25 BASS BOOST indicator (22)

Rear Panel

RX-8030VBK

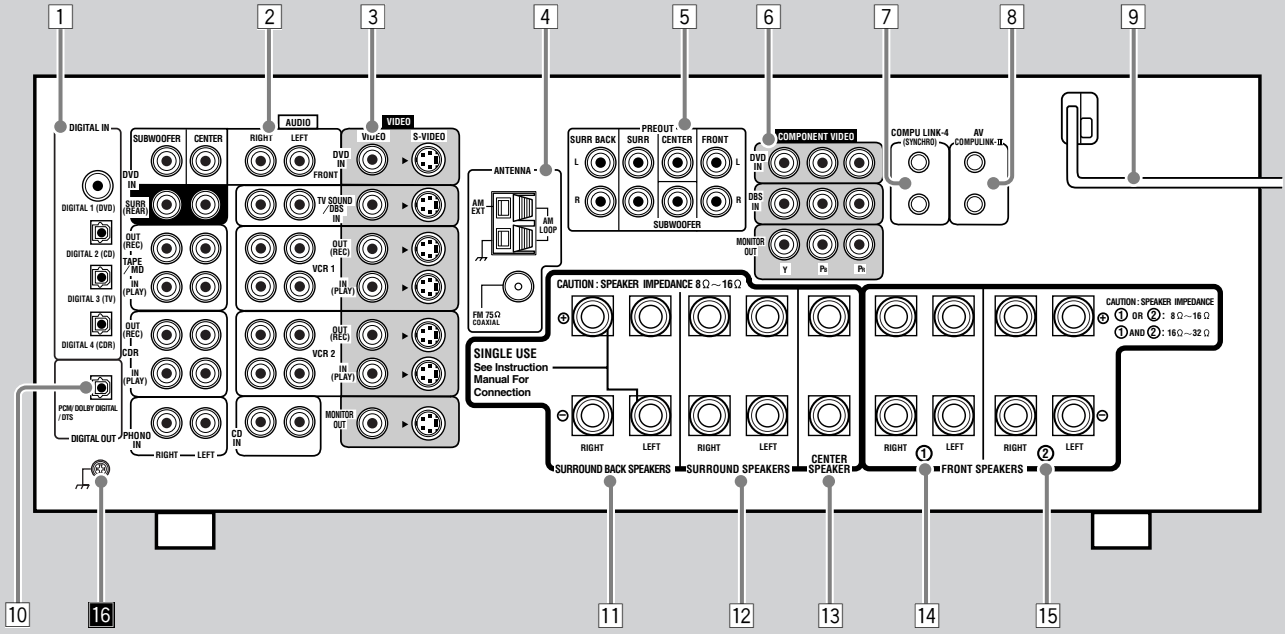

RX-7030VBK

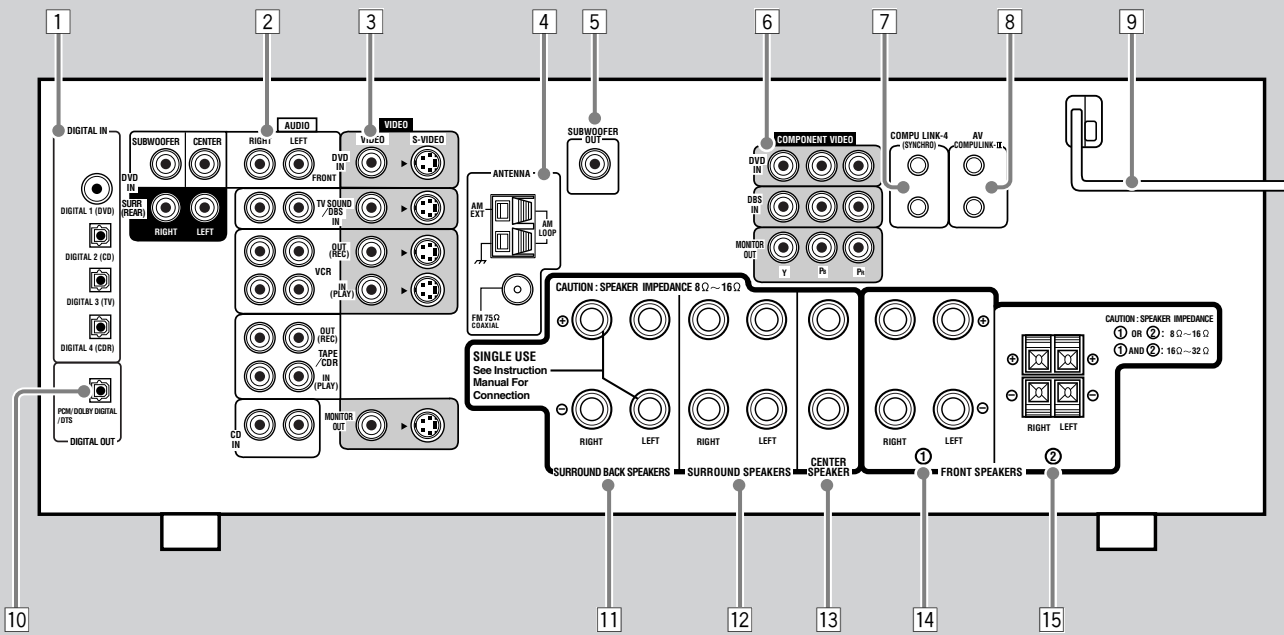

Rear Panel

RX-8030VBK

- 1 DIGITAL IN terminals (16)
 - Coaxial: DIGITAL 1 (DVD)
 - Optical: DIGITAL 2 (CD), DIGITAL 3 (TV), DIGITAL 4 (CDR)
- 2 AUDIO input/output jacks (11 – 15)
 - Input: DVD IN—FRONT, CENTER, SUBWOOFER, SURR (REAR), TV SOUND/DBS IN, VCR 1 IN (PLAY), VCR 2 IN (PLAY), CD IN, TAPE/MD IN (PLAY), CDR IN (PLAY), PHONO IN
 - Output: VCR 1 OUT (REC), VCR 2 OUT (REC), TAPE/MD OUT (REC), CDR OUT (REC)
- 3 S-VIDEO and composite VIDEO input/output jacks (14, 15)
 - Input: DVD IN, TV SOUND/DBS IN, VCR1 IN (PLAY), VCR 2 IN (PLAY)
 - Output: VCR 1 OUT (REC), VCR 2 OUT (REC), MONITOR OUT
- 4 FM/AM ANTENNA terminals (8)
- 5 PREOUT jacks (10, 11)
 - FRONT, CENTER, SUBWOOFER, SURR, SURR BACK
- 6 COMPONENT VIDEO input/output jacks (14, 15)
 - Input: DVD IN, DBS IN
 - Output: MONITOR OUT
- 7 COMPU LINK-4 (SYNCHRO) terminals (41)
- 8 AV COMPULINK-III terminals (42)
- 9 AC power cord (16)
- 10 DIGITAL OUT terminal (16)
- 11 SURROUND BACK SPEAKERS terminal (10)
- 12 SURROUND SPEAKERS terminal (10)
- 13 CENTER SPEAKER terminal (10)
- 14 FRONT SPEAKERS ① terminals (10)
- 15 FRONT SPEAKERS ② terminals (10)
- 16 Earth (ground) terminal (11)

RX-7030VBK

- 1 DIGITAL IN terminals (16)
 - Coaxial: DIGITAL 1 (DVD)
 - Optical: DIGITAL 2 (CD), DIGITAL 3 (TV), DIGITAL 4 (CDR)
- 2 AUDIO input/output jacks (12 – 15)
 - Input: DVD IN—FRONT, CENTER, SUBWOOFER, SURR (REAR), TV SOUND/DBS IN, VCR IN (PLAY), TAPE/CDR IN (PLAY), CD IN
 - Output: VCR OUT (REC), TAPE/CDR OUT (REC)
- 3 S-VIDEO and composite VIDEO input/output jacks (14, 15)
 - Input: DVD IN, TV SOUND/DBS IN, VCR IN (PLAY)
 - Output: VCR OUT (REC), MONITOR OUT
- 4 FM/AM ANTENNA terminals (8)
- 5 SUBWOOFER OUT jack (10)
- 6 COMPONENT VIDEO input/output jacks (14, 15)
 - Input: DVD IN, DBS IN
 - Output: MONITOR OUT
- 7 COMPU LINK-4 (SYNCHRO) terminals (41)
- 8 AV COMPULINK-III terminals (42)
- 9 AC power cord (16)
- 10 DIGITAL OUT terminal (16)
- 11 SURROUND BACK SPEAKERS terminal (10)
- 12 SURROUND SPEAKERS terminal (10)
- 13 CENTER SPEAKER terminal (10)
- 14 FRONT SPEAKERS ① terminals (10)
- 15 FRONT SPEAKERS ② terminals (10)

Differences between RX-8030VBK and RX-7030VBK

○: Supplied ×: Not supplied

| | Video jacks (input/output) | PREOUT jacks | CC Converter | Selectable source |
|-------------------|---|--------------|--------------|--|
| RX-8030VBK | Composite video (4/3) S-video (4/3) Component video (2/1) | ○ | ○ | DVD MULTI, DVD, VCR 1, VCR 2, VIDEO, TV SOUND/DBS, PHONO, CD, CDR, TAPE/MD, FM, AM |
| RX-7030VBK | Composite video (3/2) S-video (3/2) Component video (2/1) | × | × | DVD MULTI, DVD, VCR, TV SOUND/DBS, CD, TAPE/CDR, FM, AM |

| Remote Control | Display Window | Color |
|--------------------|----------------|-------|
| RM-SRX8030J | ○ | Black |
| RM-SRX7030J | × | Black |

Getting Started

This section explains how to connect audio/video components and speakers to the receiver, and how to connect the power supply.

Before Installation

General Precautions

- Be sure your hands are dry.
- Turn the power off to all components.
- Read the manuals supplied with the components you are going to connect.

Locations

- Install the receiver in a location that is level and protected from moisture.
- The temperature around the receiver must be between -5°C and 35°C (23°F and 95°F).
- Make sure there is good ventilation around the receiver. Poor ventilation could cause overheating and damage the receiver.

Handling the receiver

- Do not insert any metal object into the receiver.
- Do not disassemble the receiver or remove screws, covers, or cabinet.
- Do not expose the receiver to rain or moisture.

Checking the Supplied Accessories

Check to be sure you have all of the following items, which are supplied with the receiver.

The number in the parentheses indicates quantity of the pieces supplied.

- Remote Control (1)
- Batteries (2)
- AM Loop Antenna (1)
- FM Antenna (1)

If anything is missing, contact your dealer immediately.

Putting Batteries in the Remote Control

Before using the remote control, insert the two supplied batteries first.

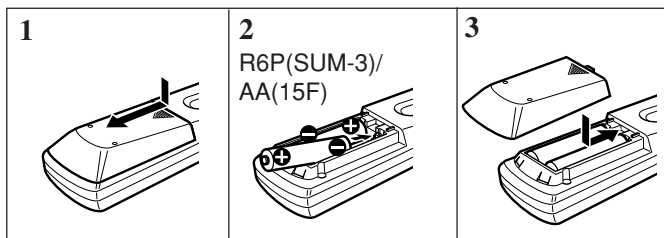

1. Press and slide the battery cover on the back of the remote control.

2. Insert the batteries.

- Make sure to match the polarity: (+) to (+) and (-) to (-).

3. Replace the cover.

If the remote control cannot transmit signals or operate the receiver correctly, replace the batteries. Use two R6P(SUM-3)/AA(15F) type dry-cell batteries.

Notes:

- Supplied batteries are for the initial setup. Replace for continued use.
- After replacing the batteries, set the manufacturers' codes again (see pages from 47 to 49).

CAUTION:

Follow these precautions to avoid leaking or cracking cells:

- Place batteries in the remote control so they match the polarity: (+) to (+) and (-) to (-).
- Use the correct type of batteries. Batteries that look similar may differ in voltage.
- Always replace both batteries at the same time.
- Do not expose batteries to heat or flame.

Connecting the FM and AM Antennas

FM Antenna Connections

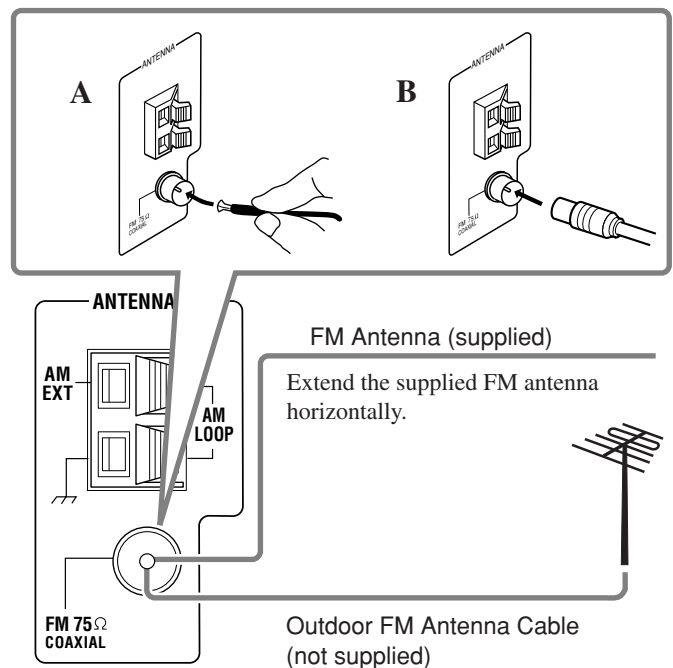

A. Using the Supplied FM Antenna

The FM antenna provided can be connected to the FM 75 Ω COAXIAL terminal as temporary measure.

B. Using the Standard Type Connector (Not Supplied)

A standard type connector should be connected to the FM 75 Ω COAXIAL terminal.

Note:

If reception is poor, connect the outdoor FM antenna (not supplied). Before attaching a 75 Ω coaxial cable with a connector (the kind with a round wire going to an outdoor antenna), disconnect the supplied FM antenna.

AM Antenna Connections

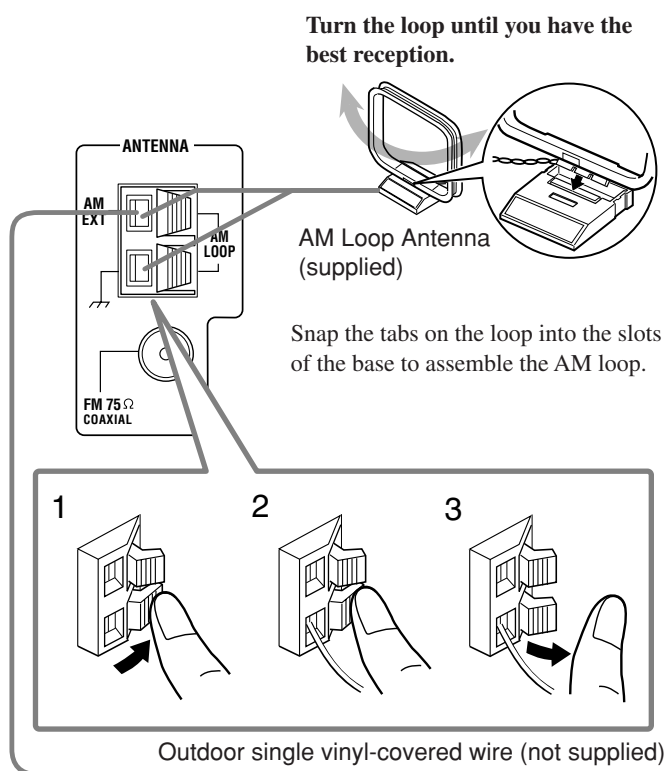

Notes:

- If the AM loop antenna wire is covered with vinyl, remove the vinyl by twisting it as illustrated.
- Make sure the antenna conductors do not touch any other terminals, connecting cords and power cord. This could cause poor reception.
- If reception is poor, connect an outdoor single vinyl-covered wire (not supplied) to the AM EXT terminal. (Keep the AM loop antenna connected.)

Connecting the Speakers

You can connect the following speakers:

- Two pairs of front speakers to produce normal stereo sound.
- One pair of surround speakers to enjoy the surround effect.
- One surround back speaker or one pair of surround back speakers to enjoy to produce more effective surround effect.
- One center speaker to emphasize human voices.
- One subwoofer to enhance the bass.

CAUTION:

Use only the speakers of the SPEAKER IMPEDANCE indicated by the speaker terminals.

- **When connecting to both of the FRONT SPEAKERS ① and ② terminals, use speakers with an impedance of 16 Ω to 32 Ω.**
- **When connecting to either the FRONT SPEAKERS ① or ② terminals, use speakers with an impedance of 8 Ω to 16 Ω.**

Basic connecting procedure

1 Twist and remove the insulation at the end of each speaker signal cable (not supplied).



2 Open the speaker terminal.

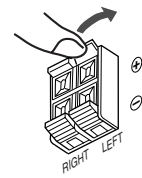
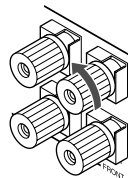

RX-7030VBK
(For FRONT SPEAKERS 2 terminals)

3 Insert the speaker signal cable.

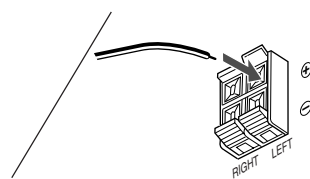
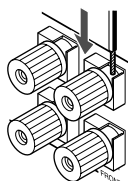

4 Close the speaker terminal.

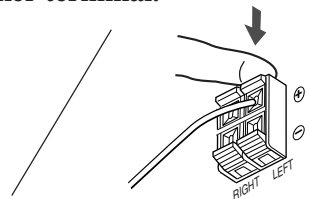
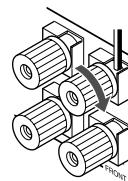

For each speaker (except for a subwoofer), connect the (+) and (-) terminals on the rear panel to the (+) and (-) terminals marked on the speakers.

Speaker layout

Ideal speaker layout varies depending on the conditions of your listening room. The diagram below is a recommended typical example.

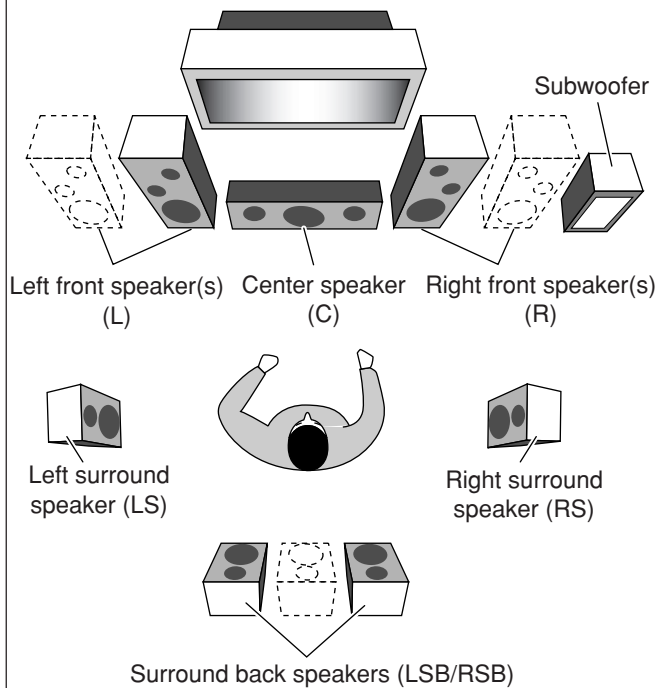

- Rear terminals of RX-8030VBK are used for explanation.

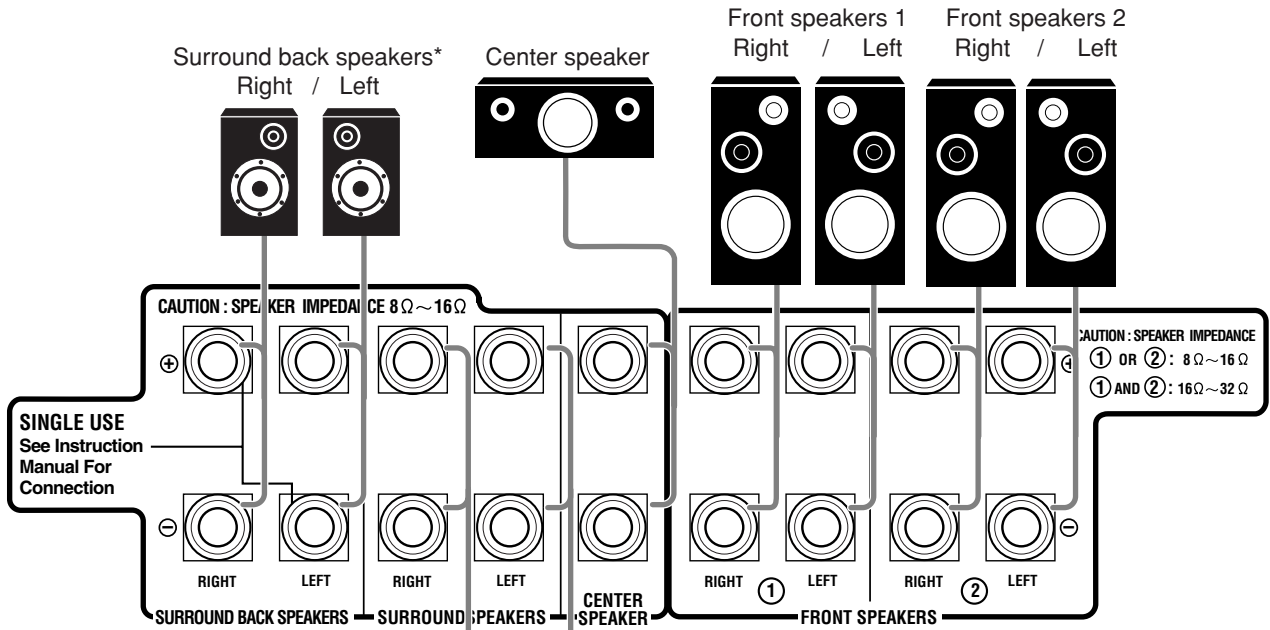

* When using only one surround back speaker, connect the ⊕ cord to the RIGHT ⊕ terminal and the ⊖ cord to the LEFT ⊖ terminal.

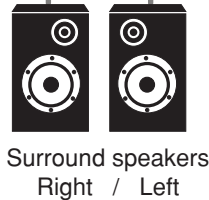

IMPORTANT:

After connecting the speakers, set the speaker installation information properly. You can use Quick Speaker Setup for easy speaker installation information setting (see page 25).

- To obtain the best possible Surround/DSP effect, see “Setting the Speakers” on page 27.

Connecting the subwoofer speaker

You can enhance the bass by connecting a subwoofer. Connect the input jack of a powered subwoofer to the rear panel, using a cable with RCA pin plugs (not supplied).

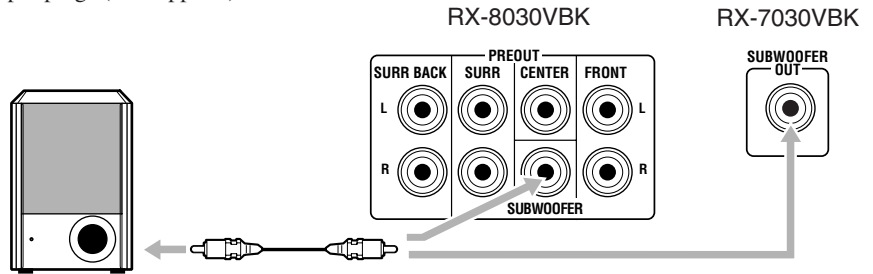

Placing speakers

Front speakers and center speaker

- Place these speakers (position of the mid-range speaker units) at the same height from the floor.
- Point these speakers aiming at the listener’s ears.

Surround and surround back speakers

- Place these speakers at a position which is 1 meter higher than the listener’s ears.
- Point these speakers down aiming at the listener’s ears.

Subwoofer

- You can place it wherever you like since bass sound is non-directional. Normally place it in front of you.

Note:

Ideal speaker layout requires that all speakers be placed at the same distance from the listener. However, since in some places it may be difficult to fulfil this requirement, this unit can adjust the delay time so that the sounds through all the speakers reach the listener with the same timing. (See page 28.)

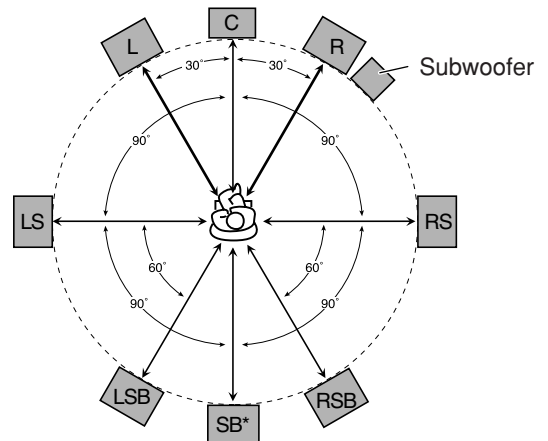

* When one surround back speaker is connected.

Enhancing your audio system —Only for RX-8030VBK



You can use this receiver as the pre-amplifier (control amplifier) when you connect power amplifiers to the PREOUT jacks on the rear using cables with RCA pin plugs (not supplied).

- Connect the white plug to the audio left jack, and the red plug to the audio right jack.

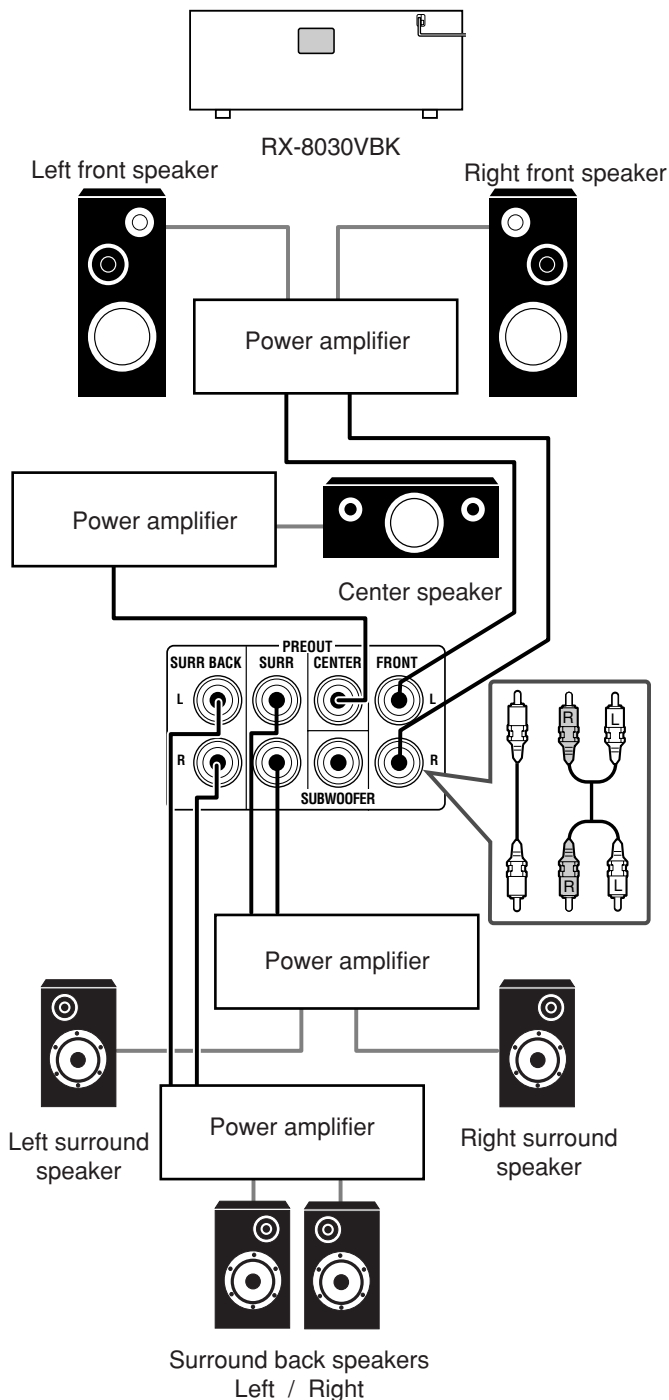

Note:

If you connect one surround back speaker, connect the surround back speaker to the left surround back PREOUT jack (SURR BACK L).

Connecting Audio/Video Components

When connecting individual components, refer also to the manuals supplied with them.

Analog Connections

If your audio components have digital audio output terminal, connecting them using the digital cords explained in “Digital Connections” (see page 16) will give you better sound quality.

Audio component connections

Use the cables with RCA pin plugs (not supplied).

- Connect the white plug to the audio left jack, and the red plug to the audio right jack.

If your audio components have a COMPU LINK jack

See also page 41 for detailed information about the connection and the COMPU LINK remote control system.

CAUTION:

If you connect a sound-enhancing device such as a graphic equalizer between the source components and this receiver, the sound output through this receiver may be distorted.

Turntable



To listen to the sound after connection, press PHONO.

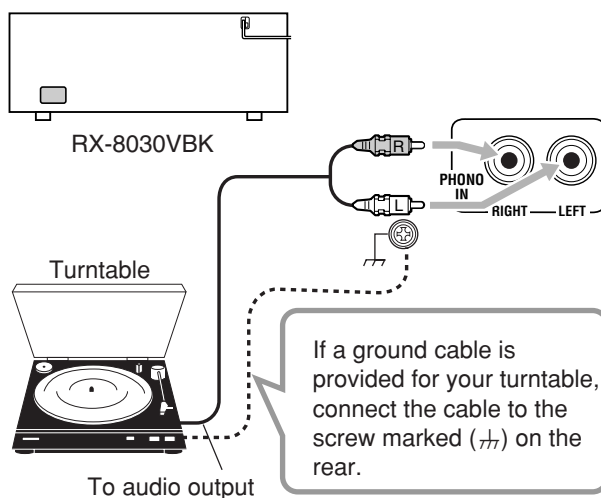

Note:

This connection is for the turntable with an MM (moving-magnet) type cartridge.

Any turntables incorporating a small-output cartridge such as an MC (moving-coil) type must be connected to this receiver through a commercial head amplifier or step-up transformer. Direct connection may result in insufficient volume.

CD player

To listen to the sound after connection, press CD.

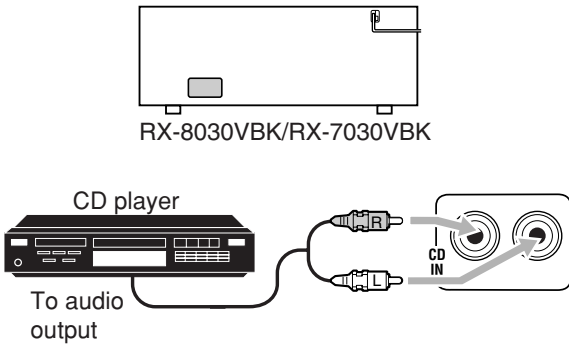

Cassette deck

To listen to the sound after connection, press TAPE/MD (for RX-8030VBK) or TAPE/CDR (for RX-7030VBK).

For RX-8030VBK

You can connect either a cassette deck or an MD recorder to the TAPE/MD jacks. When connecting an MD recorder, see page 13.

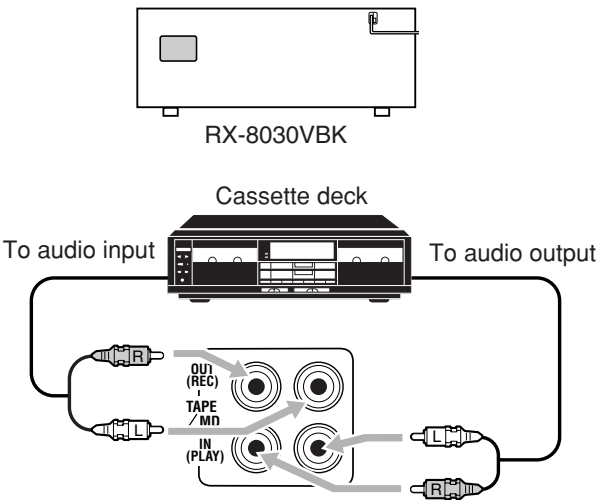

For RX-7030VBK

You can connect either a cassette deck or a CD recorder to the TAPE/CDR jacks. When connecting an CD recorder to the TAPE/CDR jacks, see the right column.

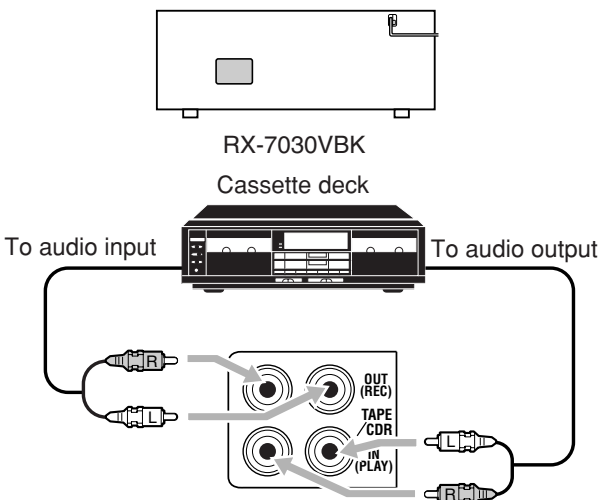

CD recorder

To listen to the sound after connection, press CDR (for RX-8030VBK) or TAPE/CDR (for RX-7030VBK).

For RX-8030VBK

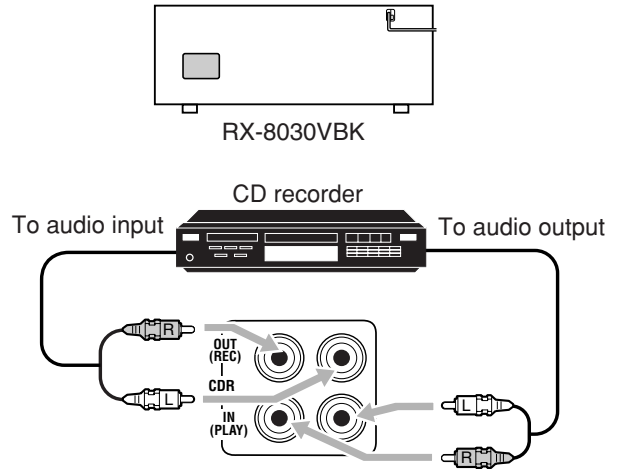

For RX-7030VBK

You can connect either a CD recorder or a cassette deck to the TAPE/CDR jacks. When connecting a cassette deck to the TAPE/CDR jacks, see the left column.

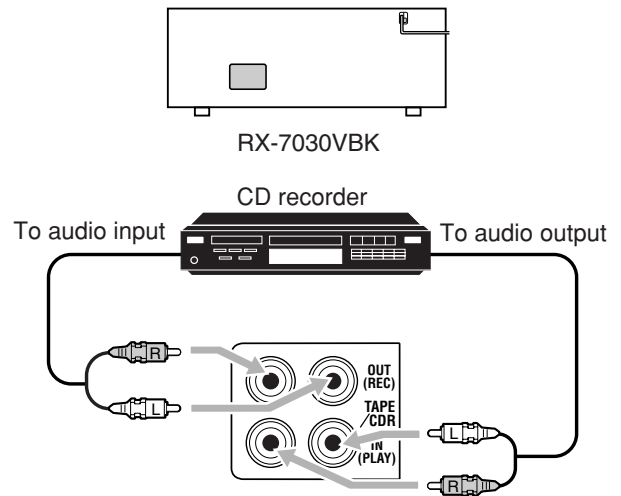

Note:

For RX-7030VBK: When connecting a CD recorder to the TAPE/CDR jacks, change the source name to "CDR," which will be shown on the display when it is selected as the source. See page 21 for details.

MD recorder

To listen to the sound after connection, press TAPE/MD (for RX-8030VBK) or TAPE/CDR (for RX-7030VBK).

For RX-8030VBK

You can connect either an MD recorder or a cassette deck to the TAPE/MD jacks. When connecting a cassette deck, see page 12.

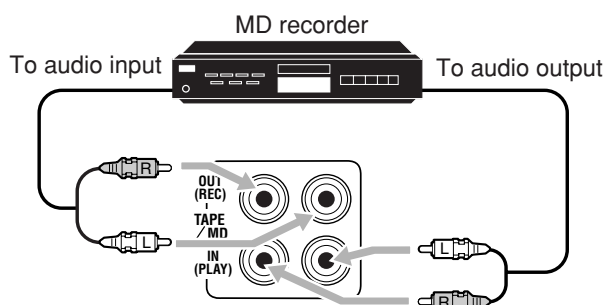
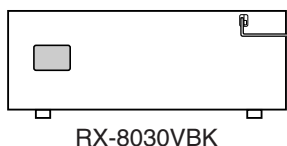

Note:

When connecting an MD recorder to the TAPE/MD jacks, change the source name to "MD," which will be shown on the display when it is selected as the source. See page 21 for details.

For RX-7030VBK

You can connect an MD recorder to the TAPE/CDR jacks if they are not used for connecting another component such as a cassette deck or CD recorder. When connecting an MD recorder to the TAPE/CDR jacks, see page 12.

- Though your MD recorder is one of JVC products with the COMPU LINK remote control system, you cannot use the COMPU LINK remote control system to operate the connected MD recorder.

Video component connections

Use the cables with RCA pin plugs (not supplied). Connect the white plug to the audio left jack, the red plug to the audio right jack, and the yellow plug to the video jack.

- If your video components have S-video (Y/C-separation) and/or component video (Y, Pb, Pr) terminals, connect them using an S-video cable (not supplied) and/or component video cable (not supplied). By using these jacks, you can get better picture quality in the order—Component video > S-video > Composite video.

If your video components have an AV COMPULINK jack

See also page 42 for detailed information about the connection and the AV COMPU LINK remote control system.

IMPORTANT:

This receiver is equipped with the following video jacks—composite video, S-video and component video jacks. You can use any of the three to connect a video component.

However, **the video signals from one type of these input jacks are transmitted only through the video output jacks of the same type.**

Therefore, if a recording video component and a playing video component are connected to the receiver through the video jacks of different type, you cannot record the picture. In addition, if the TV and a playing video component are connected to the receiver through the video jacks of different type, you cannot view the playback picture on the TV.

Video camera



To listen to the sound after connection, press VIDEO.

The VIDEO input jacks on the front panel (inside the front door) are convenient when connecting and disconnecting the component frequently.

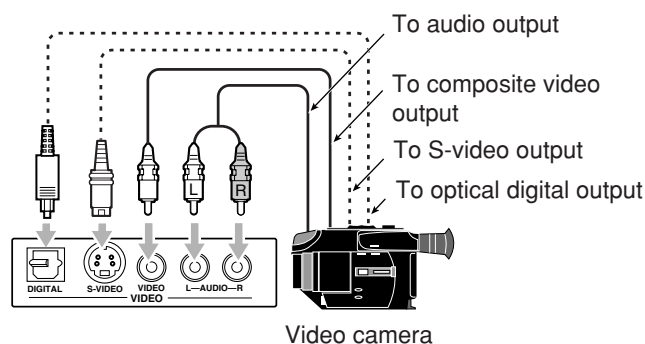
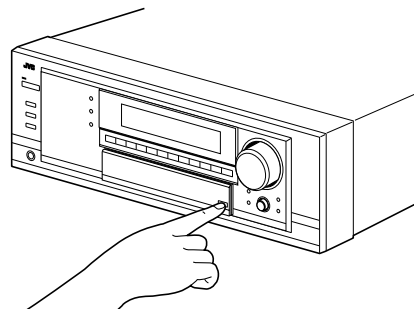

When using the digital input terminal

Select the digital input mode correctly.

For details, see "Selecting the Analog or Digital Input Mode" on page 19.

VCR(s)

To listen to the sound after connection, press VCR 1 or VCR 2 (for RX-8030VBK) or VCR (for RX-7030VBK).

For RX-8030VBK

You can connect two VCRs—one to the VCR 1 jacks and the other to the VCR 2 jacks.

- If your VCR has an AV COMPU LINK jack, connect it to the VCR 1 jack so that you can use the AV COMPU LINK remote control system.

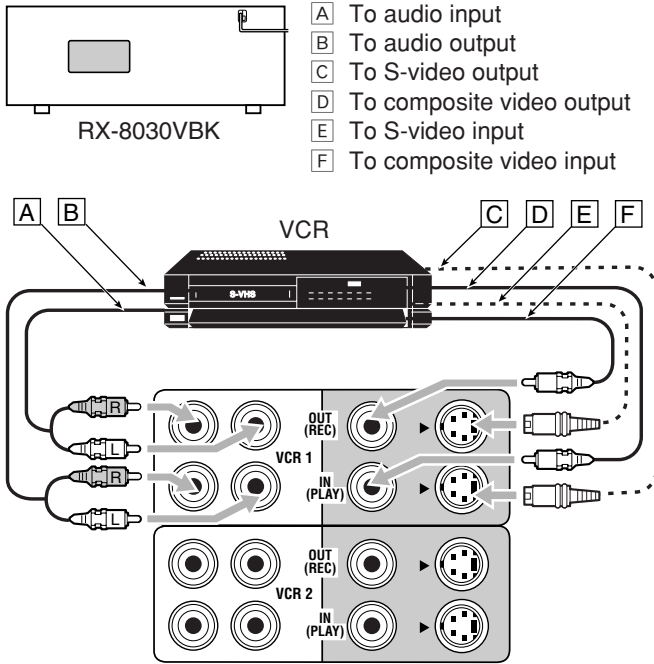

For RX-7030VBK

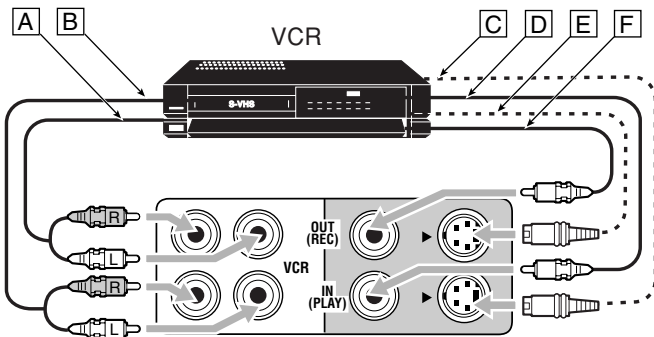
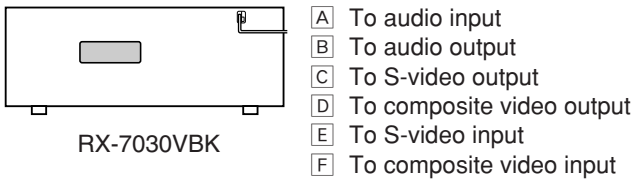

TV and/or DBS tuner

To listen to the sound after connection, press TV SOUND/DBS (or TV/DBS on the remote control).

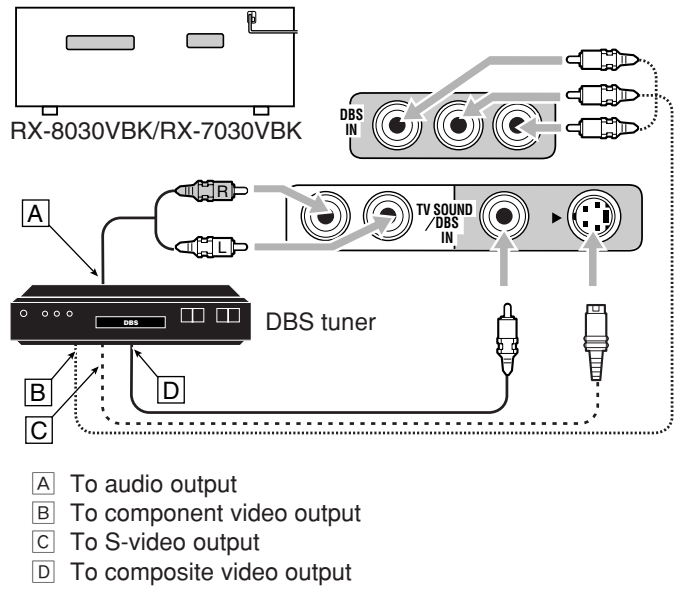
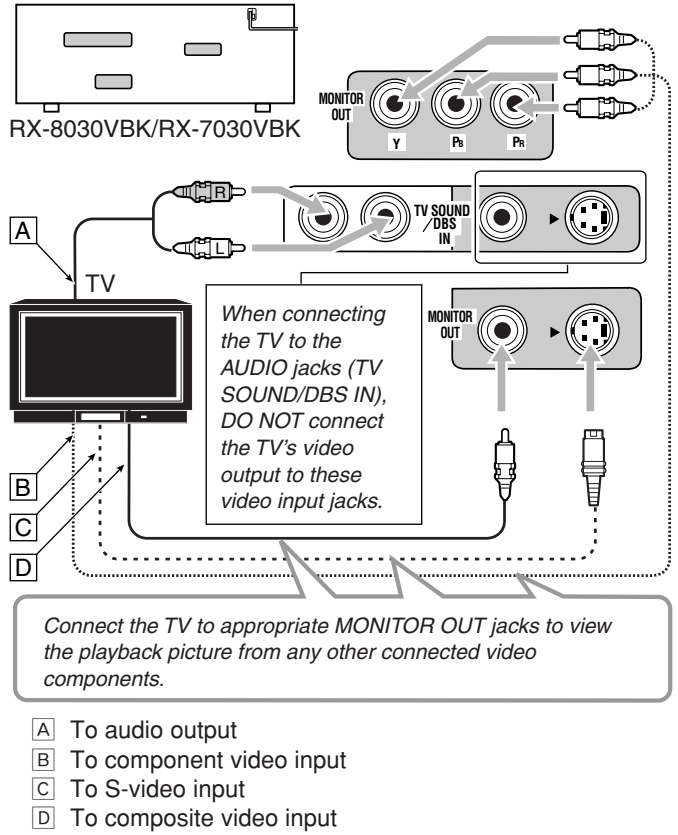

Notes:

- When connecting a DBS tuner to the TV SOUND/DBS IN jacks, change the source name to "DBS," which will be shown on the display when selected as the source. Otherwise you cannot view any picture from DBS tuner. See page 21 for details.
- When connecting a DBS tuner to either one of the component input jacks, make the component video input setting correctly for AV COMPU LINK. See page 30 for details.

DVD player

- When you connect a DVD player with stereo output jacks:

To listen to the sound after connection, press DVD.

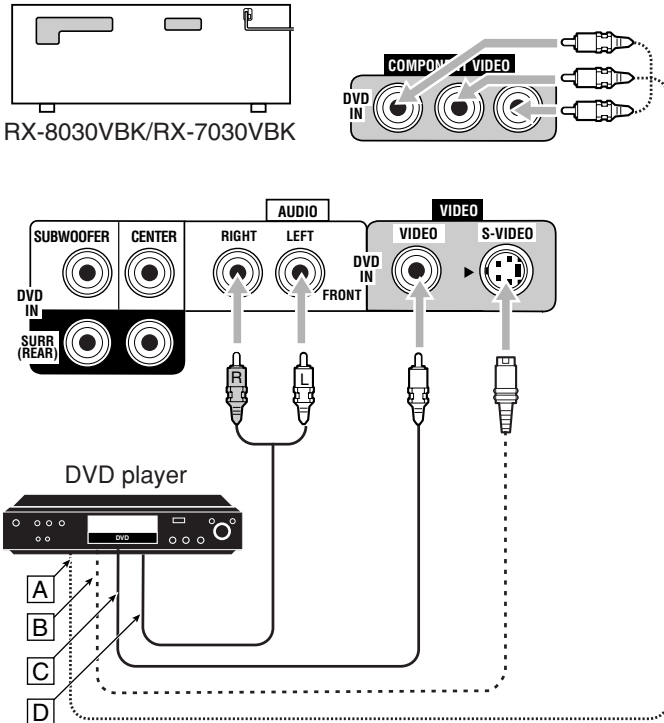

- A To component video output
- B To S-video output
- C To composite video output
- D To left/right front channel audio output (or to audio-mixed output if necessary)

Note:

When connecting a DVD player to the component video input jacks, make the component video input setting correctly for AV COMPU LINK. See page 30 for details.

- When you connect a DVD player with its analog discrete output (5.1-channel reproduction) jacks:

To listen to the sound after connection, press DVD MULTI.

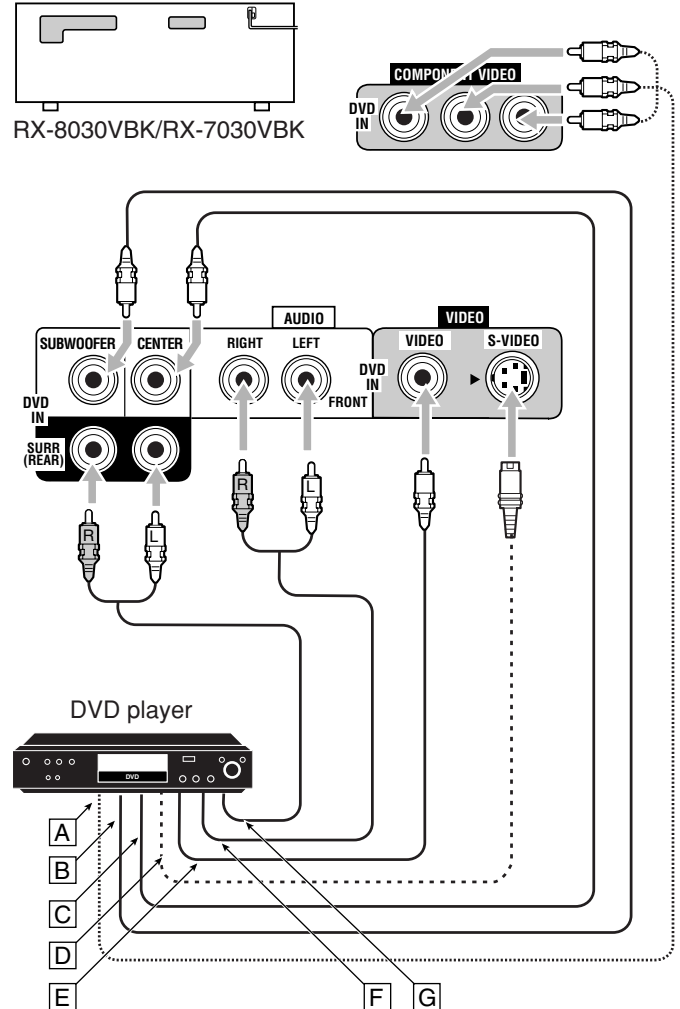

- A To component video output
- B To subwoofer output
- C To center channel audio output
- D To S-video output
- E To composite video output
- F To left/right front channel audio output
- G To left/right surround channel audio output

Note:

When connecting a DVD player to the component video input jacks, make the component video input setting correctly for AV COMPU LINK. See page 30 for details.

Digital Connections

This receiver is equipped with four DIGITAL IN terminals—one digital coaxial terminal and three digital optical terminals—and one DIGITAL OUT (optical) terminal on the rear.

- For **RX-8030VBK**: Another digital optical input terminal is located on the front panel (see page 13).

IMPORTANT:

- When connecting a DVD player, digital TV broadcast tuner or DBS tuner using the digital terminals, you also need to connect it to the video jacks on the rear. Without connecting it to the video jacks, you can view no playback picture.
- After connecting the components using the DIGITAL IN terminals, set the following correctly if necessary.
 - Set the digital input (DIGITAL IN) terminal setting correctly. For details, see “Setting the Digital Input Terminals” on page 29.
 - Select the digital input mode correctly. For details, see “Selecting the Analog or Digital Input Mode” on page 19.

Digital input terminals

You can connect any digital components having coaxial or optical digital output terminal.

Digital coaxial cable (not supplied)
between digital coaxial terminals



Digital optical cable (not supplied)
between digital optical terminals

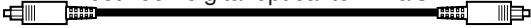

When the component has a digital coaxial output terminal, connect it to the DIGITAL 1 (DVD) terminal, using a digital coaxial cable (not supplied).

When the component has a digital optical output terminal, connect it to the DIGITAL 2 (CD), DIGITAL 3 (TV) or DIGITAL 4 (CDR) terminal, using a digital optical cable (not supplied).

Before connecting a digital optical cable, unplug the protective plug.

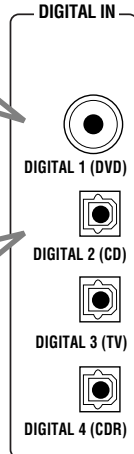
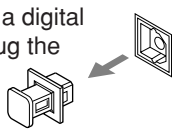

Digital output terminal

You can connect any digital components which have an optical digital input terminal.

Digital optical cable (not supplied)
between digital optical terminals



When the digital recording equipment such as an MD recorder and CD recorder has a digital optical input terminal, connecting it to the DIGITAL OUT terminal enables you to perform digital-to-digital recording.

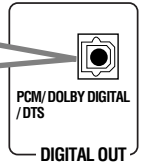

Note:

The digital signal format transmitted through the DIGITAL OUT terminal is the same as that of the input signal. This means that when the DTS Digital Surround signals are input, the DTS Digital Surround signals are transmitted.

Connecting the Power Cord

Before plugging the receiver into an AC outlet, make sure that all connections have been made.

Plug the power cord into an AC outlet.

Keep the power cord away from the connecting cables and the antenna. The power cord may cause noise or screen interference.

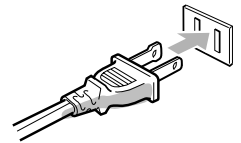

Note:

The preset settings such as preset channels and sound adjustment may be erased in a few days in the following cases:

- When you unplug the power cord.
- When a power failure occurs.

CAUTIONS:

- Do not touch the power cord with wet hands.
- Do not pull on the power cord to unplug the cord. When unplugging the cord, always grasp the plug so as not to damage the cord.

Notes:

- When shipped from the factory, the DIGITAL IN terminals have been set for use with the following components:
 - DIGITAL 1 (coaxial): For DVD player
 - DIGITAL 2 (optical): For CD player
 - DIGITAL 3 (optical): For digital TV broadcast tuner
 - DIGITAL 4 (optical): For CD recorder
- When you want to operate the CD player or CD recorder, (or MD recorder: only for RX-8030VBK) using the COMPU LINK remote control system, connect the target component also as described in “Analog Connections” (see pages 12 and 13).
- When you want to operate a DVD player using the AV COMPU LINK remote control system (see page 42), connect the DVD player also as described in “Analog Connections” (see page 15).

Basic Operations

The following operations are commonly used when you play any sound sources.

Operations hereafter will be explained using the buttons on the front panel.

You can also use the buttons on the remote control for the same functions if they have the same and similar names/marks.

Daily Operational Procedure

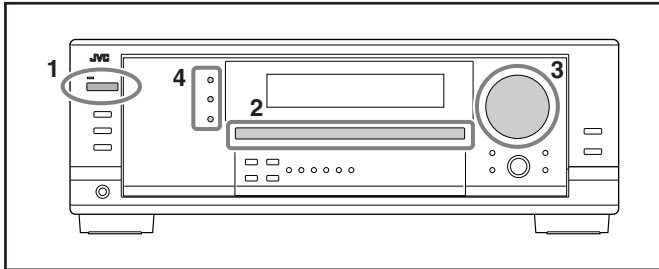

- 1 Turn on the power.**
 - See “Turning On the Power” below.
- 2 Select the source.**
 - See “Selecting the Source to Play” to the right.
- 3 Adjust the volume.**
 - See “Adjusting the Volume” on page 18.
- 4 Select the surround or DSP modes.**
 - See “Activating the Surround Modes” (page 37) and “Activating the DSP Modes” (page 39).

Selecting the Source to Play

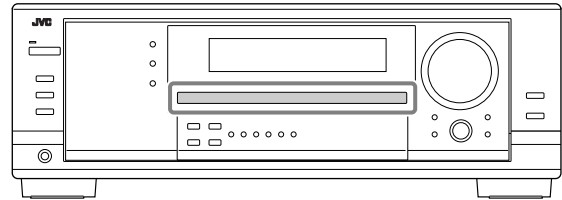

Press one of the source selection buttons.

- The selected source name and the previously selected Surround/DSP mode also appear on the display.

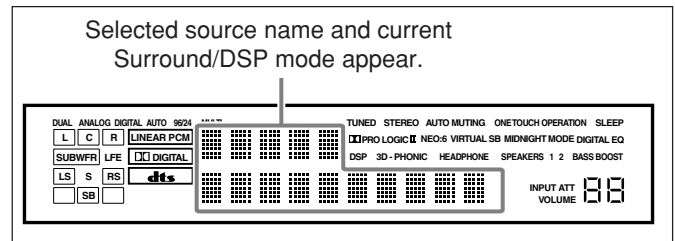

For RX-8030VBK

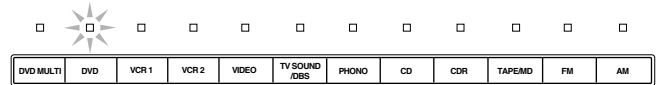

On the unit

- The lamp on the selected source lights up (ex. when DVD is selected as the source).



On the remote

Turning On the Power

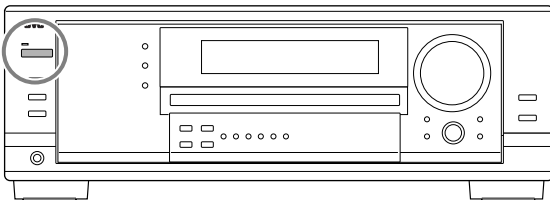

Press **STANDBY/ON** (or **AUDIO** on the remote control).

The STANDBY lamp goes off. The name of the current source and Surround/DSP mode appear on the display.

Current source name and Surround/DSP mode appear

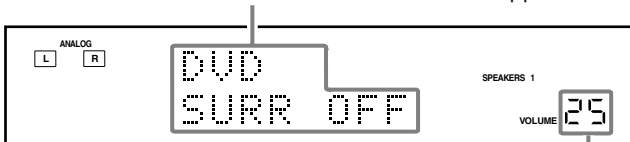

Current volume level appears.

To turn off the power (into standby mode), press **STANDBY/ON** (or **AUDIO** on the remote control) again.

The STANDBY lamp lights up.

Note:

A small amount of power is consumed in standby mode. To turn off the power completely, unplug the AC power cord.

For RX-7030VBK

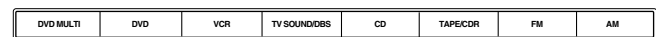

On the unit



On the remote

Notes:

- For RX-8030VBK: When connecting an MD recorder (to the TAPE/MD jack) and a DBS tuner (to the TV SOUND/DBS jacks), change the source names shown on the display. For details, see page 21.
- For RX-7030VBK: When connecting an CD recorder (to the TAPE/CDR jacks) and a DBS tuner (to the TV SOUND/DBS jacks), change the source names shown on the display. For details, see page 21.

Speaker and signal indicators on the display

By checking the following indicators, you can easily confirm which speakers you are activating and which signals are coming into this receiver.

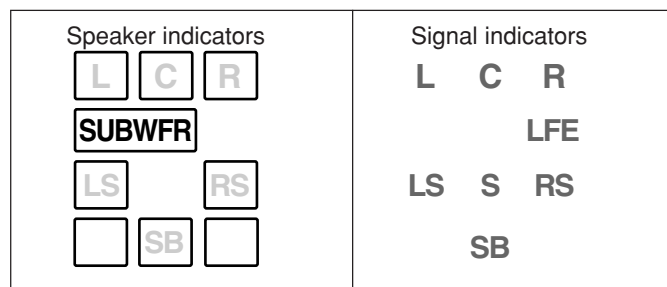

What speaker indicators light depends on the speaker setting (for details, see "Setting the Speakers" on page 27).

- The frames of "L," "C," "R," "LS," "RS," and "SB" light up, when the corresponding speakers are set to "LARGE" or "SMALL" and when the speaker is required for the Surround/DSP mode currently selected.
- When "SUB WOOFER" is set to "YES," [SUBWFR] lights up (see page 27).
- All three frames on the row of "SB" are not used at the same time. When "SBACK OUT" is set to "2SPK," the left and the right ones are used. When it is set to "1SPK," the middle one is used (see page 27).

The signal indicators light up to show the incoming signals.

- L: • **When digital input is selected:** Lights up when the left channel signal comes in.
- **When analog input is selected:** Always lights up.
- R: • **When digital input is selected:** Lights up when the right channel signal comes in.
- **When analog input is selected:** Always lights up.
- C: Lights up when the center channel signal comes in.
- LFE: Lights up when the LFE channel signal comes in.
- LS: Lights up when the left surround channel signal comes in.
- RS: Lights up when the right surround channel signal comes in.
- S: Lights up when the monaural surround channel signal comes in.
- SB: Lights up when the surround back channel signal comes in.

Note:

When "DVD MULTI" is selected as the source, "L," "C," "R," "LFE," "LS," and "RS" light up.

How to understand the speaker and signal indicator illumination

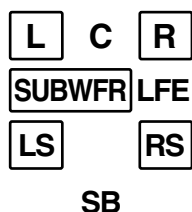

Ex. No sound comes out of the center speaker and surround back speakers though center channel and surround back channel signals are coming into this receiver.

Selecting different sources for picture and sound

While watching pictures from a video source, you can listen to sound of an audio source.

- Once you have selected a video source, pictures of the selected source are sent to the TV until you select another video source.

Press one of the audio source selection buttons while viewing the picture from a video component such as the VCR or DVD player, etc.

For RX-8030VBK



On the unit

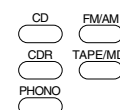

On the remote

For RX-7030VBK

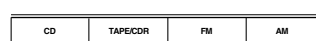

On the unit



On the remote

Note:

When you see the picture through the COMPONENT VIDEO jacks, you cannot use this function.

Adjusting the Volume

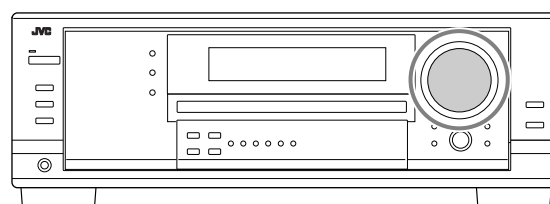

On the front panel:

To increase the volume, turn MASTER VOLUME clockwise.

To decrease the volume, turn it counterclockwise.

From the remote control:

To increase the volume, press VOLUME +.

To decrease the volume, press VOLUME -.

CAUTION:

Always set the volume to the minimum before starting any sources. If the volume is set at its high level, the sudden blast of sound energy can permanently damage your hearing and/or ruin your speakers.

Notes:

- The volume level can be adjusted within the range of "0" (minimum) to "70" (maximum).
- If you set One Touch Operation to "ON" (see page 30), you do not have to adjust the volume level each time you change the source. It is automatically set to the stored level.

Selecting the Front Speakers



When you have connected two pairs of the front speakers, you can select which to use.

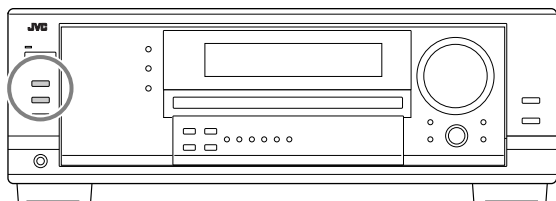

To use the speakers connected to the FRONT SPEAKERS ① terminals, press SPEAKERS ON/OFF 1 so that the SPEAKERS 1 indicator lights up on the display. Make sure that the SPEAKERS 2 indicator is not lit on the display.

To use the speakers connected to the FRONT SPEAKERS ② terminals, press SPEAKERS ON/OFF 2 so that SPEAKERS 2 indicator lights up on the display. Make sure that the SPEAKERS 1 indicator is not lit on the display.

To use both sets of the speakers, press SPEAKERS ON/OFF 1 and SPEAKERS ON/OFF 2 so that the SPEAKERS 1/2 indicators light up on the display.

To use neither sets of the speakers, press SPEAKERS ON/OFF 1 and SPEAKERS ON/OFF 2 so that the SPEAKERS 1/2 indicators go off from the display.

The HEADPHONE indicator lights up and “HEADPHONE” appears on the display.

- Activating the speakers turns on the Surround and DSP modes previously selected.

Listening with headphones only:

Deactivate both sets of the front speakers, and connect headphones to the PHONES jack.

You can enjoy the sound effects through the headphones when Surround or DSP mode is activated—3D HEADPHONE (3D H PHONE) mode.

- “3D H PHONE” appears on the display and the DSP and HEADPHONE indicator lights up on the display. (For details, see page 36.)

Note:

When you select “DVD MULTI” as the source or any one of the Surround/DSP mode which activates the center and/or surround speaker(s), you can use only one set of the speakers.

CAUTION:

Be sure to turn down the volume:

- Before connecting or putting on headphones, as its high volume can damage both the headphones and your hearing.
- Before turning on speakers again, as its high volume may come out of the speakers.

Activating and Adjusting the Subwoofer Sound



You can cancel the subwoofer sound even though you have connected a subwoofer and have set “SUB WOOFER” to “YES” (see page 27). This is useful when enjoying surround sound at night.

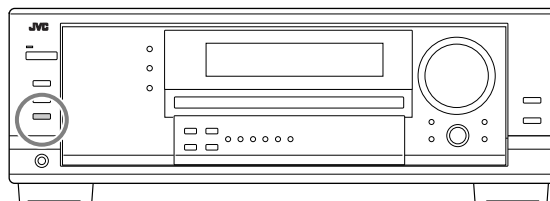

Press SUBWOOFER OUT ON/OFF to cancel the subwoofer sound output.

Each time you press the button, subwoofer sound output is deactivated (“SUBWFR OFF”) and activated (“SUBWFR ON”) alternately.

- When subwoofer sound output is activated, subwoofer output level can be adjusted using the remote control.
 - 1 Press SOUND.
 - 2 Press SUBWOOFER.
 - 3 Press LEVEL + or – to adjust the output level (–10 dB to +10 dB).

Note:

You cannot deactivate the subwoofer sound output when you set “SMALL” for the front speakers on the Speaker size setting (see page 27) or Quick Speaker Setup (see page 25).

Selecting the Analog or Digital Input Mode

When you have connected digital source components using the digital terminals (see page 16), change the input mode for these components to the digital input mode.

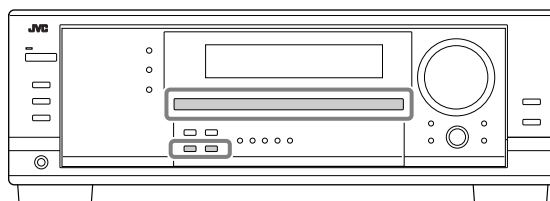

Before you start, remember...

The digital input terminal setting should be correctly done for the sources you want to select the digital input mode (see “Setting the Digital Input Terminals” on pages 29 and 30).

1. Press one of the source selection buttons for which you want to change the input mode.

- **For RX-8030VBK:** DVD, VIDEO, TV (SOUND)/DBS, CD, CDR, or TAPE/MD*
- **For RX-7030VBK:** DVD, TV (SOUND)/DBS, CD, or TAPE/CDR*

* If “TAPE” is selected as the source, digital input mode is not available. To change the source name, see “Changing the Source Name” on page 21.

Continued on the next page

2. Press INPUT DIGITAL (or ANALOG/DIGITAL INPUT on the remote control) to select “DGTL AUTO.”

The DIGITAL AUTO indicator lights up on the display.

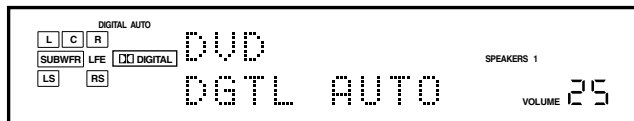

- When selecting “DGTL AUTO,” the following indicators indicate the digital signal format of the incoming signal.

LINEAR PCM : Lights up when Linear PCM signals come in.

DIGITAL : Lights up when Dolby Digital signals come in.

dts : Lights up when DTS signals come in.

No indicator lights up when the receiver cannot recognize the digital signal format of the incoming signals.

When playing software encoded with the Dolby Digital or DTS, the following symptoms may occur:

- Sound does not come out at the beginning of playback.
- Noise comes out while searching for or skipping chapters or tracks.

In this case, press INPUT DIGITAL repeatedly to select “DGTL D.D” or “DGTL DTS” while “DGTL AUTO” still remains on the display.



- As you press INPUT DIGITAL, the input mode changes as follows:

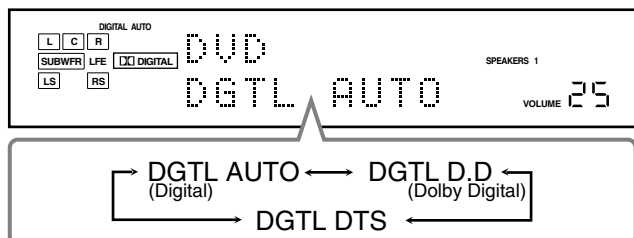

When “DGTL D.D” or “DGTL DTS” is selected, the AUTO indicator goes off, and the corresponding digital signal format indicator lights up on the display.

- If the incoming signal does not match the selected digital signal format, the frame of the selected indicator will flash.

Note:

When you turn off the power or select another source, “DGTL D.D” and “DGTL DTS” settings are canceled and the digital input mode is automatically reset to “DGTL AUTO.”

To select the analog input mode again

Press INPUT ANALOG (or press ANALOG/DIGITAL INPUT on the remote control repeatedly until “ANALOG” appears on the display). The ANALOG indicator lights up.



Setting the Dynamic Range

You can enjoy a powerful sound at night using the Midnight Mode.

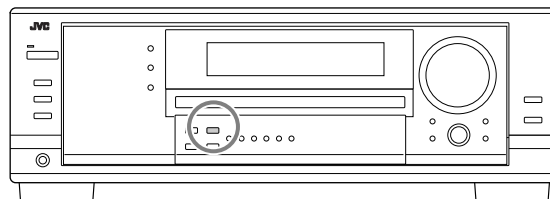

Press MIDNIGHT MODE so that “MID NIGHT 1” or “MID NIGHT 2” appears on the display.

The MIDNIGHT MODE indicator also lights up.

MID NIGHT 1: Select when you want to reduce the dynamic range a little.

MID NIGHT 2: Select when you want to apply the compress effect fully (useful at midnight).

MID NIGHT OFF: Select when you want to enjoy surround with its full dynamic range (no effect applied).

Notes:

- If Analog Direct is in use, Midnight Mode is temporarily canceled.
- Midnight Mode is not valid for DVD MULTI playback mode.

Attenuating the Input Signal



When the input level of the analog source is too high, the sounds will be distorted. If this happens, you need to attenuate the input signal level to prevent the sound distortion.

- Once you have made adjustment, it is memorized for each analog source.

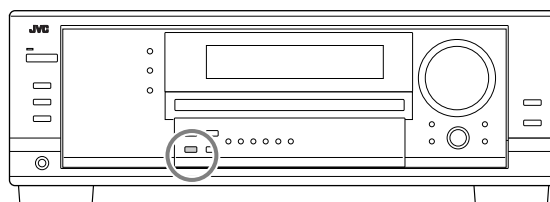

Press and hold INPUT ATT (INPUT ANALOG) so that the INPUT ATT indicator lights up on the display.

- Each time you press and hold the button, the input attenuator mode turns on (“ATT ON”) or off (“NORMAL”).

Note:

This function is not valid when “DVD MULTI” is selected or when Analog Direct is activated.

Turning Analog Direct On and Off

You can enjoy the sound closer to the original source by overriding the sound adjustments such as speaker output level adjustments (see page 32), Digital Equalization (see page 32), Surround and DSP modes (see pages 34 to 39), Bass Boost (see page 22) and Midnight Mode (see page 20). You can only adjust the volume level while Analog Direct is in use.

- Once you have made adjustment, it is memorized for each analog source.

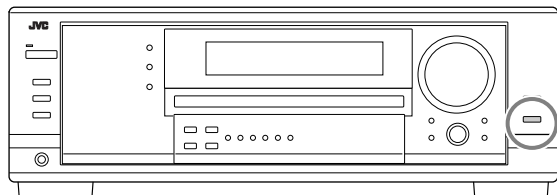

Press **ANALOG DIRECT** so that **"A DIRECT"** appears on the display.

The lamp on the button also lights up.

- Each time you press the button, Analog Direct turns on and off.

Notes:

- When digital input mode is in use, Analog Direct is not available.
- Turning on Surround or DSP mode cancels Analog Direct and previously selected sound adjustments are recalled.
- If Analog Direct is in use, Midnight Mode is temporarily canceled.
- Turning on Analog Direct cancels Input Attenuator (page 20) (and CC Converter for RX-8030VBK: below).

Making Sounds Natural



JVC's CC (Compensative Compression) Converter eliminates jitter and ripples, achieving a drastic reduction in digital distortion by processing the digital music data in 24 bit-quantization and by expanding the sampling frequency to 128 kHz (for fs 32 kHz signals)/176.4 kHz (for fs 44.1 kHz signals)/192 kHz (for fs 48 kHz signals).

By using CC Converter, you can obtain a natural sound field from both digital and analog sources.

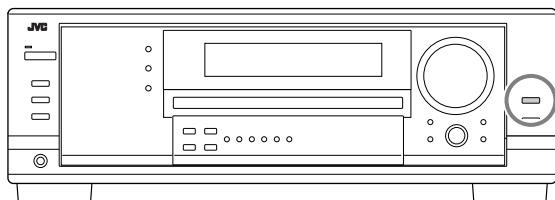

Press **CC CONVERTER** so that the lamp on the button lights up.

- Each time you press the button, CC Converter turns on and off (the lamp goes off) alternately.

Note:

You cannot use this function while Analog Direct is in use. If you turn on Analog Direct while this function is in use, this function will be canceled.

Changing the Source Name



When you have connected an MD recorder to the TAPE/MD jacks or a DBS tuner to the TV SOUND/DBS jacks on the rear panel, change the source name which will be shown on the display.

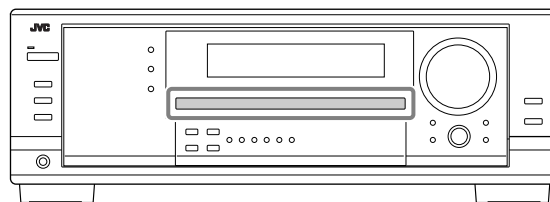

When changing the source name from **"TV"** to **"DBS"**:

1. Press **TV SOUND/DBS**.
 - Make sure **"TV"** appears on the display.
2. Press and hold **TV SOUND/DBS** until **"ASSGN DBS"** appears on the display.



Note:

When connecting a DBS tuner to the TV SOUND/DBS IN jacks, change the source name to **"DBS,"** which will be shown on the display when selected as the source. Otherwise you cannot view any picture from DBS tuner.

For **RX-8030VBK**:

When changing the source name from **"TAPE"** to **"MD"**:

1. Press **TAPE/MD**.
 - Make sure **"TAPE"** appears on the display.
2. Press and hold **TAPE/MD** until **"ASSGN MD"** appears on the display.

For **RX-7030VBK**:

When changing the source name from **"TAPE"** to **"CDR"**:

1. Press **TAPE/CDR**.
 - Make sure **"TAPE"** appears on the display.
2. Press and hold **TAPE/CDR** until **"ASSGN CDR"** appears on the display.

To change the source name to **"TV"** and **"TAPE,"** repeat the same procedure above.

Note:

Without changing the source name, you can still use the connected components. However, there may be some inconvenience.

- For **RX-8030VBK**:
 - **"TAPE"** or **"TV"** will appear on the display when you select the MD recorder or DBS tuner.
 - You cannot use the digital input (see pages 19 and 20) for the MD recorder.
 - You cannot use the COMPU LINK remote control system (see pages 41) to operate the MD recorder.
- For **RX-7030VBK**:
 - **"TAPE"** or **"TV"** will appear on the display when you select the CD recorder or DBS tuner.
 - You cannot use the digital input (see pages 19 and 20) for the CD recorder.

The following basic operations are possible only using the remote control.

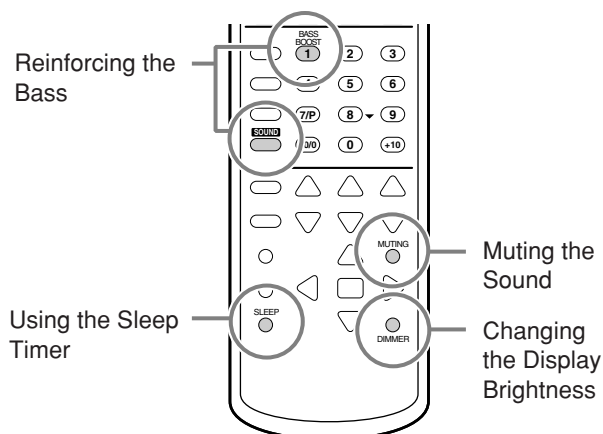

Reinforcing the Bass

You can boost the bass level.

- Once you have made adjustment, it is memorized for each source.

1. Press SOUND.

The 10 keys are activated for sound adjustments.

2. Press BASS BOOST to turn on Bass Boost.

The BASS BOOST indicator lights up.

- Each time you press the button, Bass Boost turns on (“BOOST ON”) and off (“BOOST OFF”) alternately.

For RX-7030VBK:

You can use the BASS BOOST button on the front panel.



When the Bass Boost is activated, the lamp on the button lights up.

- Each time you press the button, Bass Boost turns on and off.

Notes:

- This function affects only the sounds from the front speakers, center speaker, and subwoofer.
- When Analog Direct is in use (see page 21), the Bass Boost is canceled temporarily.

Muting the Sound

Press MUTING to mute the sound through all speakers and headphones connected.

“MUTING” appears on the display and the volume turns off (the VOLUME level indicator goes off).

To restore the sound, press MUTING again.

- Turning MASTER VOLUME on the front panel or pressing VOLUME +/- on the remote control also restores the sound.

Changing the Display Brightness

You can dim the display.

Press DIMMER.

- Each time you press the button, the brightness level of the display change as follows:

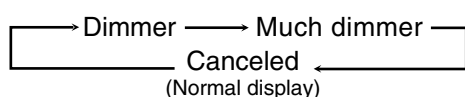

Using the Sleep Timer

Using the Sleep Timer, you can fall asleep while listening to music. When the shut-off time comes, the receiver turns off automatically.

Press SLEEP repeatedly.

The SLEEP indicator lights up on the display, and the shut-off time changes in 10 minutes intervals:

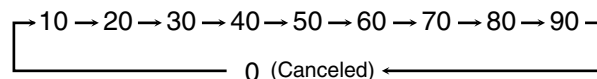

To check or change the time remaining until the shut-off time:

Press SLEEP once.

The remaining time until the shut-off time appears in minutes.

- To change the shut-off time, press SLEEP repeatedly.

To cancel the Sleep Timer:

Press SLEEP repeatedly until “SLEEP 0min” appears on the display. (The SLEEP indicator goes off.)

- Turning off the power also cancels the Sleep Timer.

Recording a source

For analog-to-analog recording

You can record any analog playback source onto the recording components connected to the audio output jacks on the rear of this unit at the same time.

For digital-to-digital recording

You can record the currently selected digital input source through the receiver to a digital recording device connected to the DIGITAL OUT terminal.

Notes:

- Analog-to-digital and digital-to-analog recordings are not possible.
- The output volume level, Midnight Mode (see page 20), Bass Boost (see the left column), Digital Equalization (see page 32), Surround modes and DSP modes (see pages 34 to 39) cannot affect the recording.

Basic adjustment auto memory

This receiver memorizes sound settings for each source—

- when you turn off the power,
- when you change the source, and
- when you assign the source name (see page 21).

When you change the source, the memorized settings for the newly selected source are automatically recalled.

The following can be stored for each source:

- Analog/digital input mode (see pages 19 and 20)
- Input attenuator mode (see page 20)
- Analog Direct (see page 21)
- Digital Equalization (see page 32)
- Speaker channel output levels (see page 32)
- Surround and DSP mode selection (see pages 37 and 39)
- Bass Boost setting (see the left column)

Notes:

- If the source is FM or AM, you can assign a different setting for each band.
- If you want to memorize the volume level with the above settings, set One Touch Operation to “ON” (see page 30).

Receiving Radio Broadcasts

You can browse through all the stations or use the preset function to go immediately to a particular station.

Tuning in to Stations Manually

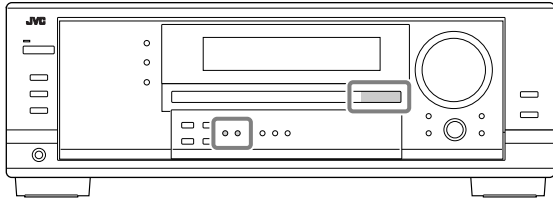

1. Press FM or AM to select the band.

The last received station of the selected band is tuned in.

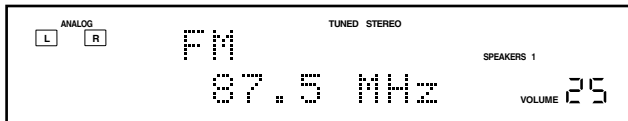

2. Press FM/AM TUNING ▲ or ▼ repeatedly until you find the frequency you want.

- Pressing FM/AM TUNING ▲ increases the frequency.
- Pressing FM/AM TUNING ▼ decreases the frequency.

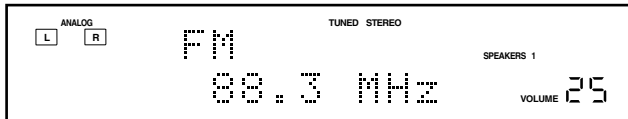

Notes:

- When a station of sufficient signal strength is tuned in, the TUNED indicator lights up on the display.
- When an FM stereo program is received, the STEREO indicator also lights up.
- When you hold and then release the button in step 2, the frequency keeps changing until a station is tuned in.

From the remote control:

1. Press FM/AM.
 - Each time you press the button, the band alternates between FM and AM.
2. Press TUNING UP or TUNING DOWN repeatedly until you find the frequency you want.
 - Pressing TUNING UP increases the frequency.
 - Pressing TUNING DOWN decreases the frequency.

Using Preset Tuning

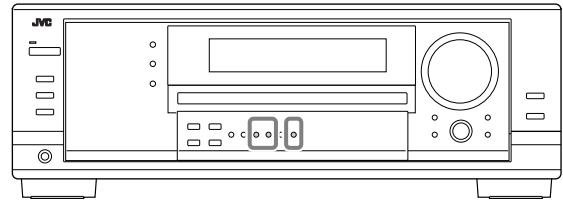

Once a station is assigned to a channel number, the station can be quickly tuned in. You can preset up to 30 FM and 15 AM stations.

To store the preset stations

Before you start, remember..

There is a time limit in doing the following steps. If the setting is canceled before you finish, start from step 2 again.

On the front panel ONLY:

1. Tune in the station you want to preset (see “Tuning in to Stations Manually” on the left).

- If you want to store the FM reception mode for this station, select the FM reception mode you want. See “Selecting the FM Reception Mode” on page 24.

2. Press MEMORY.

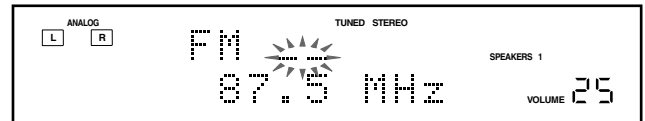

The channel number position starts flashing on the display for about 10 seconds.

3. Press FM/AM PRESET ▲ or ▼ to select a channel number while the channel number position is flashing.

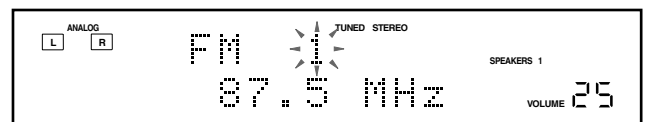

4. Press MEMORY again while the selected channel number is flashing.

The selected channel number stops flashing.

The station is assigned to the selected channel number.

5. Repeat steps 1 to 4 until you store all the stations you want.

To erase a stored preset station

Storing a new station on a used number erases the previously stored one

To tune in a preset station

On the front panel:

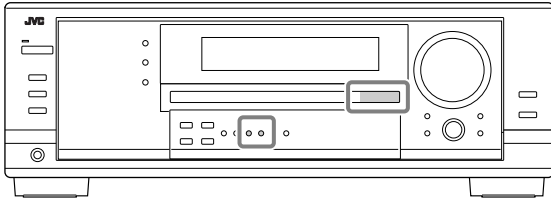

- 1. Press FM or AM to select the band.**
The last received station of the selected band is tuned in.
- 2. Press FM/AM PRESET ▲ or ▼ until you find the channel you want.**
 - Pressing FM/AM PRESET ▲ increases the number.
 - Pressing FM/AM PRESET ▼ decreases the number.

From the remote control:

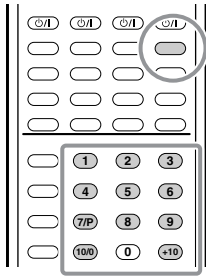

- 1. Press FM/AM to select the band.**
The last received station of the selected band is tuned in.
 - Each time you press the button, the band alternates between FM and AM.
- 2. Press the 10 keys to select a preset channel number.**
 - For channel number 5, press 5.
 - For channel number 15, press +10 then 5.
 - For channel number 20, press +10 then 10.
 - For channel number 30, press +10, +10, then 10.

Note:

When you use the 10 keys on the remote control, be sure that they are activated for the tuner, not for the CD and others. (See page 44.)

Selecting the FM Reception Mode

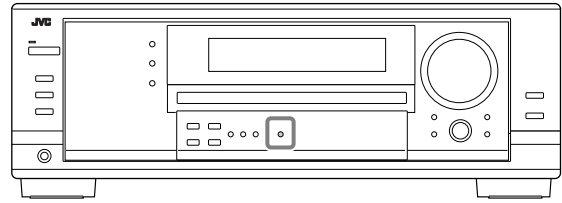

When an FM stereo broadcast is hard to receive or noisy, you can change the FM reception mode while receiving an FM broadcast.

- You can store the FM reception mode for each preset station (see page 23).

While listening to an FM station, press FM MODE.

- Each time you press the button, the FM reception mode alternates between “AUTOMUTING” and “MODE MONO.”

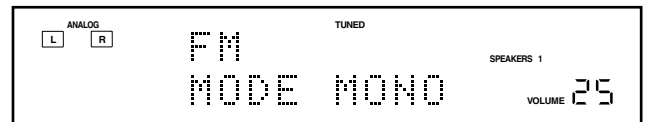

-
- AUTOMUTING:** Normally select this.
When a program is broadcasted in stereo, you will hear stereo sound; when in monaural, you will hear monaural sounds.
This mode is also useful to suppress static noise between stations. The AUTO MUTING indicator lights up on the display. (Initial setting)
-
- MODE MONO:** Select this to improve the reception (but stereo effect will be lost).
In this mode, you will hear noise while tuning into the stations. The AUTO MUTING indicator goes off from the display. (The STEREO indicator also goes off.)
-

Note:

When you use the FM MODE on the remote control, be sure that it is activated for the tuner, not for the CD and others. (See page 44.)

Basic Settings

Some of the following settings are required after connecting and positioning your speakers while others will make operations easier. You can use QUICK SPEAKER SETUP to easily set up your speaker configuration.

Setting the Speakers Configuration



Quick Speaker Setup helps you to easily and quickly register the speaker size and speaker distance according to your listening room to create the best possible surround effect.

- You can also register each speaker's information manually. For details, see page 27.

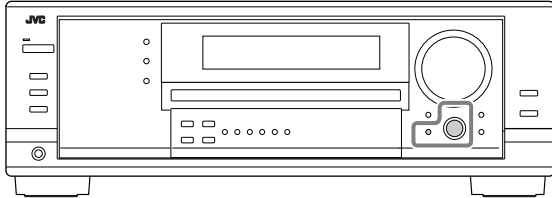

Before you start, remember...

There is a time limit in doing the following steps. If the setting is canceled before you finish, start from step 1 again.

On the front panel:

1. Press QUICK SPEAKER SETUP.

“SETUP” and “SPEAKERS?” appear on the display, then the initial setting for the total number of the connected speakers (channels) appears.

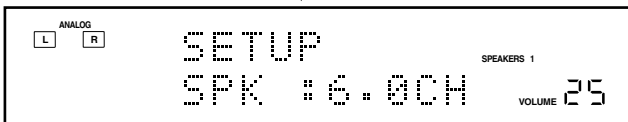
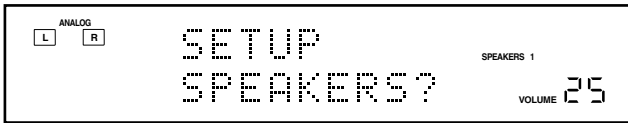

2. Turn MULTI JOG to select an appropriate number of the connected speakers (speaker channel number).

The speaker channel number changes as follows.

- For the details of speaker channel number, see “Speakers (channels) number and the size” on page 26.



2.0CH ⇄ 2.1CH ⇄ 3.0CH ⇄ 3.1CH ⇄ 4.0CH ⇄
4.1CH ⇄ 5.0CH ⇄ 5.1CH ⇄ **6.0CH*** ⇄ 6.1CH ⇄
7.0CH ⇄ 7.1CH ⇄ (Back to the beginning)

* “6.0CH” is the initial setting.

3. Press in MULTI JOG (PUSH SET).

“ROOM SIZE?” appear on the display, then the initial room size setting appears.

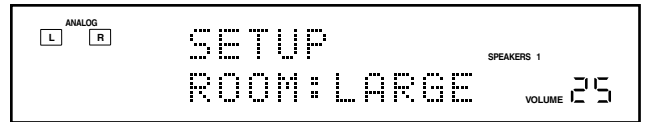

4. Turn MULTI JOG to select an appropriate room size to match to your listening room.

The room size changes as follows.

- To select your appropriate room size, see “Room size and the speaker distance” on page 26.



SMALL ⇄ MID ⇄ **LARGE*** ⇄ (Back to the beginning)

* “LARGE” is the initial setting.

5. Press in MULTI JOG (PUSH SET).

“COMPLETE” appears on the display, then goes back to the source indication.

- Speaker configuration settings now become active.



Note:

This procedure will not be completed if you stop in the middle of the setting process.

Speakers (channels) number and the size

You can find how each of the speaker size is defined according to the number of connected speakers (speaker channel (CH) number) you select.

In the following tables, “L” stands for “left front speaker,” “R” for “right front speaker,” “C” for “center speaker,” “LS” for “left surround speaker,” “RS” for “right surround speaker,” “SB” for “surround back speaker,” and “SUBWFR” for “subwoofer.”

- Subwoofer is counted as 0.1 channel.

| CH | The size of connected speakers | | | | | | |
|-----|--------------------------------|-------|-------|-------|-------|--------|--------|
| | L | R | C | LS | RS | SB | SUBWFR |
| 2.0 | LARGE | LARGE | NONE | NONE | NONE | NONE | NO |
| 2.1 | SMALL | SMALL | NONE | NONE | NONE | NONE | YES |
| 3.0 | LARGE | LARGE | SMALL | NONE | NONE | NONE | NO |
| 3.1 | SMALL | SMALL | SMALL | NONE | NONE | NONE | YES |
| 4.0 | LARGE | LARGE | NONE | SMALL | SMALL | NONE | NO |
| 4.1 | SMALL | SMALL | NONE | SMALL | SMALL | NONE | YES |
| 5.0 | LARGE | LARGE | SMALL | SMALL | SMALL | NONE | NO |
| 5.1 | SMALL | SMALL | SMALL | SMALL | SMALL | NONE | YES |
| 6.0 | LARGE | LARGE | SMALL | SMALL | SMALL | SMALL | NO |
| 6.1 | SMALL | SMALL | SMALL | SMALL | SMALL | SMALL | YES |
| 7.0 | LARGE | LARGE | SMALL | SMALL | SMALL | SMALL* | NO |
| 7.1 | SMALL | SMALL | SMALL | SMALL | SMALL | SMALL* | YES |

* This setting is applied to the both speakers.

Room size and the speaker distance

According to the selected room size, speaker distance for each activated speaker is set as follows:

| LARGE | Speaker | Distance |
|-------|---------------|---------------|
| | L | 3.0 m (10 ft) |
| R | 3.0 m (10 ft) | |
| C | 3.0 m (10 ft) | |
| LS | 3.0 m (10 ft) | |
| RS | 3.0 m (10 ft) | |
| SB | 3.0 m (10 ft) | |
| MID | Speaker | Distance |
| | L | 2.7 m (9 ft) |
| R | 2.7 m (9 ft) | |
| C | 2.4 m (8 ft) | |
| LS | 2.1 m (7 ft) | |
| RS | 2.1 m (7 ft) | |
| SB | 1.8 m (6 ft) | |
| SMALL | Speaker | Distance |
| | L | 2.4 m (8 ft) |
| R | 2.4 m (8 ft) | |
| C | 2.1 m (7 ft) | |
| LS | 1.5 m (5 ft) | |
| RS | 1.5 m (5 ft) | |
| SB | 1.2 m (4 ft) | |

Basic Setting Items

On the following pages, you can adjust the following items:

| Items | To do | See page |
|---------------------------|--|----------|
| SUB WOOFER *1 | Register your subwoofer. | 27 |
| FRONT SPEAKER *1 | Register your front speaker size. | 27 |
| CNTR SPEAKER *1 | Register your center speaker size. | 27 |
| SURR SPEAKER *1 | Register your surround speaker size. | 27 |
| SBACK SPEAKER *1 | Register your surround back speaker size. | 27 |
| SBACK OUT *1 | Register the number of the connected surround back speakers. | 27 |
| DIST UNIT | Select the measuring unit for the speaker distance. | 28 |
| FRONT DISTANCE *1 | Register the distance from you front speakers to your listening point. | 28 |
| CNTR DISTANCE *1 | Register the distance from you center speaker to your listening point. | 28 |
| SURR DISTANCE *1 | Register the distance from you surround speakers to your listening point. | 28 |
| SBACK DISTANCE *1 | Register the distance from you surround back speaker(s) to your listening point. | 28 |
| S WFR OUTPUT | Select sounds emitted from the subwoofer. | 28 |
| CROSS OVER | Select the cutoff frequency to the subwoofer. | 28 |
| LFE ATTENUATE | Attenuate the bass (LFE) sounds. | 29 |
| DUAL MONO | Select the Dual Mono sound channel. | 29 |
| DGTL IN COAX | Select the component connected to digital coaxial terminal | 29 |
| DGTL IN OPTICAL *2 | Select the components connected to digital optical terminals | 29 |
| VIDEO IN DVD | Select the type of video terminal used for the DVD player. | 30 |
| VIDEO IN DBS | Select the type of video terminal used for the DBS tuner. | 30 |
| ONE TOUCH OPE | Store the volume level for each source. | 30 |

Notes:

*1 These items can be set using Quick Speaker Setup.

*2 This setting is only for RX-8030VBK.

For RX-7030VBK, it is automatically set according to your “DGTL IN COAX” setting.

Basic Procedure

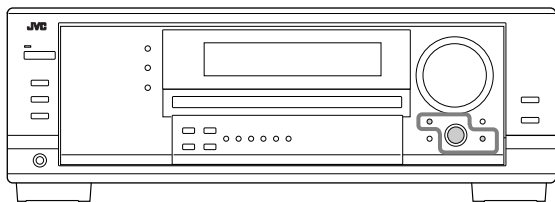

Before you start, remember...

There is a time limit in doing the following steps. If the setting is canceled before you finish, start from step 1 again.

Ex. When setting **One Touch Operation** to “ON.”

1. Press **SETTING**.

The last selected item appears on the display.



2. Turn **MULTI JOG** until an item you want appears on the display.

- In this example, select “ONE TOUCH OPE.” For available items, see the list “Basic Setting Items” on page 26.

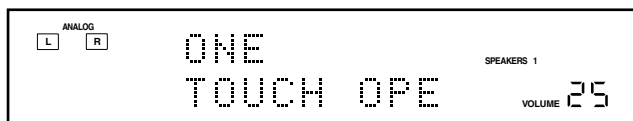

3. Push in **MULTI JOG (PUSH SET)**.

The current setting for the selected item appears on the display.



4. Turn **MULTI JOG** until a setting you want appears on the display.



5. Press **EXIT**.

6. Repeat steps 2 to 5 to set other items if necessary.

7. Press **EXIT**.

The source indication resumes on the display.

 : shows the initial setting in the following tables.

Setting the Speakers

To obtain the best possible surround effect from the Surround and DSP modes, register the setting about the speaker arrangement after all connections are completed.

- If you have used Quick Speaker Setup on page 25, this setting is not required.

■ **Subwoofer setting—SUB WOOFER**

Select whether you have connected a subwoofer or not.

YES: Select when a subwoofer is connected.

NO: Select when no subwoofer is used.

Note:

If you have selected “NO” for the subwoofer, you cannot use the **SUBWOOFER OUT ON/OFF** button on the front panel.

■ **Speaker size—FRONT SPEAKER, CNTR SPEAKER, SURR SPEAKER, SBACK SPEAKER**

Select the size for each connected speaker.

LARGE*1: Select when the speaker size is relatively large.

SMALL*2: Select when the speaker size is relatively small.

NONE: Select this when you have not connected a speaker. (Not selectable for the front speakers)

*1 Initial setting for front speakers.

*2 Initial setting for center, surround, and surround back speakers.

Notes:

- Keep the following comments in mind as reference when adjusting.
 - If the size of the cone speaker unit built in your speaker is larger than 12 cm (4 3/4 inches), select “LARGE,” and if it is smaller than 12 cm (4 3/4 inches), select “SMALL.”
- If you have selected “NO” for the subwoofer setting, you can only select “LARGE” for the front speakers.
- If you have selected “SMALL” for the front speakers, you cannot select “LARGE” for the center, surround, and surround back speakers.
- If you have selected “SMALL” for the surround speakers, you cannot select “LARGE” for the surround back speakers.
- If you have selected “NONE” for the surround speakers, the surround back speakers are fixed to “NONE.”

■ **Surround back speakers quantity—SBACK OUT**

Select the number of the surround back speakers connected.

1SPK: Select this to use 1 surround back speaker.

2SPK: Select this to use 2 surround back speakers.

Note:

If you have selected “NONE” for the surround back speakers (see above), this setting is not available.

Setting the Speaker Distance

The distance from your listening point to the speakers is another important element to obtain the best possible sound of the Surround and DSP modes. Set the distance from your listening point to the speakers.

By referring to the speaker distance setting, this unit automatically sets the delay time of the sound through each speaker so that sounds through all the speakers can reach you at the same time.

- If you have used Quick Speaker Setup on page 25, this setting is not required.

■ Measuring unit—DIST UNIT

Select which measuring unit you use.

meter: Select to set the distance in meters.

feet: Select to set the distance in feet.

■ Speaker distance—FRONT DISTANCE, CNTR DISTANCE, SURR DISTANCE, SBACK DISTANCE

Set the distance from the listening point within the range of 0.3 m (1 ft) to 9.0 m (30 ft), in 0.3 m (1 ft) intervals.

- When shipped from the factory, distance for each speaker is set to “3.0 m (10 ft).”

Notes:

- You cannot set the speaker distance for the speakers you have selected “NONE” (see page 27).
- This setting is not valid for the DVD MULTI playback mode.

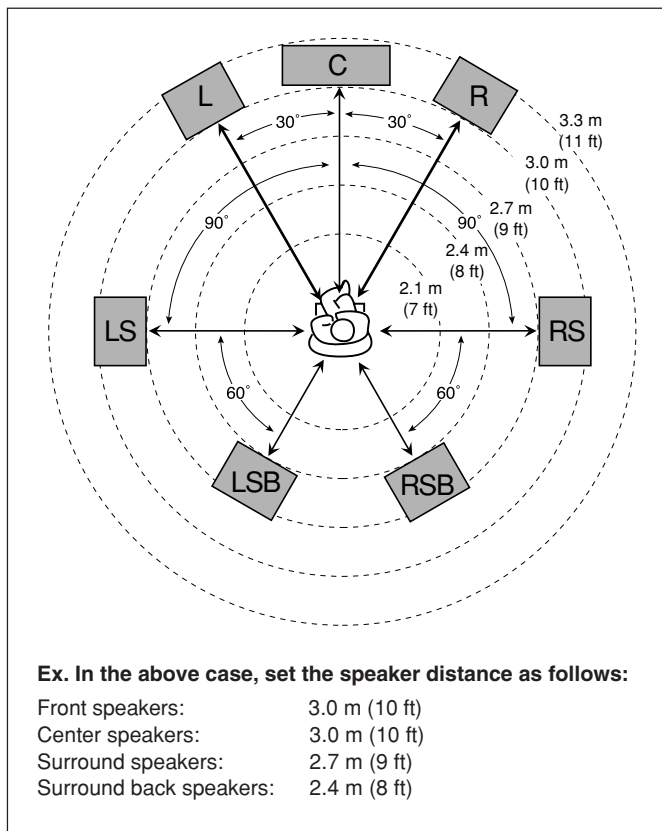

Setting the Bass Sounds

You can adjust subwoofer and bass sounds precisely according to your preference.

■ Subwoofer output—S WFR OUTPUT

You can select the type of the signal which can be transmitted through the subwoofer. In other words, you can determine whether or not the bass elements of the front speaker channels are transmitted through the subwoofer regardless of the front speaker size setting (either “SMALL” or “LARGE”).

Select one of the following:

LFE: Select to transmit only the LFE signals (while playing Dolby Digital and DTS software) and the bass elements of small speakers through the subwoofer.

LFE+MAIN: Select to always add the bass elements of the front speaker channels (MAIN) to the above (LFE) setting, and to transmit them through the subwoofer.

Note:

If you have selected “NO” for the subwoofer, this function is not available.

■ Crossover frequency—CROSS OVER

When you use a subwoofer, you can select the cutoff frequency for the small speakers used.

Select one of the crossover frequency levels according to the size of the small speaker connected.

80Hz: Select when the cone speaker unit built in the speaker is about 12 cm (4 ³/₄ inches).

100Hz: Select when the cone speaker unit built in the speaker is about 10 cm (3 ¹⁵/₁₆ inches).

120Hz: Select when the cone speaker unit built in the speaker is about 8 cm (3 ³/₁₆ inches).

150Hz: Select when the cone speaker unit built in the speaker is about 6 cm (2 ³/₈ inches).

Notes:

- If you have selected “LARGE” for all activated speakers (see page 27), this function is fixed to “OFF.”
- Crossover frequency is not valid for the DVD MULTI playback, All Channel Stereo, HEADPHONE, and 3D HEADPHONE mode.

■ Low frequency effect attenuator—LFE ATTENUATE

If the bass sound is distorted while playing back software encoded with Dolby Digital or DTS, set the LFE level to eliminate distortion.

Select one of the following:

| | |
|---------------|--|
| 0dB: | Normally select this. |
| -10dB: | Select when the bass sound is distorted. |

Selecting main or sub channel—DUAL MONO

Select the playback sounds (channel).

| | |
|--------------|--|
| MAIN: | Select to play back the main channel (Ch1). ^{*1} Signal indicator “L” lights up while playing back this channel. |
| SUB: | Select to play back the sub-channel (Ch2). ^{*1} Signal indicator “R” lights up while playing back this channel. |
| ALL: | Select to play back both the main and sub-channels (Ch1/Ch2). ^{*1} Signal indicators “L” and “R” light up while playing back these channels. |

Notes:

- The Dual Mono format is not identical with bilingual broadcasting or the MTS (Multichannel Television Sound) format used for TV programs. So this setting does not take effect while watching bilingual or MTS programs.

^{*1} Dual Mono signals can be heard from the following speakers—L (left front speaker), R (right front speaker), and C (center speaker)—with respect to the current Surround setting.

| Dual Mono Setting | Without Surround | | With Surround Activated | | | | |
|-------------------|------------------|------|-------------------------|-----------|------|-----------|-----------|
| | | | Center speaker setting | | | | |
| | | | SMALL/LARGE | | NONE | | |
| L | R | L | C | R | L | R | |
| MAIN | Ch 1 | Ch 1 | — | Ch 1 | — | Ch 1 | Ch1 |
| SUB | Ch 2 | Ch 2 | — | Ch 2 | — | Ch 2 | Ch 2 |
| ALL | Ch 1 | Ch 2 | — | Ch 1+Ch 2 | — | Ch 1+Ch 2 | Ch 1+Ch 2 |

Setting the Digital Input Terminals

When you use the digital input terminals, register which components you have connected to the digital input terminals.

■ Digital coaxial terminal—DGTL IN COAX

Set the component connected to the digital coaxial terminal (DIGITAL IN 1).

- For RX-8030VBK: DVD (initial setting), MD*, CDR, TV (or DBS**) or CD.
- For RX-7030VBK: DVD (initial setting), CD, TV (or DBS**) or CDR.

■ Digital optical terminals—DGTL IN OPTICAL

For RX-8030VBK:

Set the components connected to the digital optical terminals (DIGITAL IN 2 – 4).

- As you rotate MULTI JOG, the digital optical input terminals are set to used for following digital components:

When “DIGITAL IN 1 (DGTL IN COAX)” is set to “DVD”

| | | | |
|-------------------------|------------------|--------|---|
| 2: CD | 3: TV (or DBS**) | 4: CDR | ⇄ |
| 2: CD | 3: TV (or DBS**) | 4: MD* | ⇄ |
| 2: CD | 3: MD* | 4: CDR | ⇄ |
| 2: MD* | 3: TV (or DBS**) | 4: CDR | ⇄ |
| (back to the beginning) | | | |

When “DIGITAL IN 1 (DGTL IN COAX)” is set to “CD”

| | | | |
|-------------------------|------------------|--------|---|
| 2: DVD | 3: TV (or DBS**) | 4: CDR | ⇄ |
| 2: DVD | 3: TV (or DBS**) | 4: MD* | ⇄ |
| 2: DVD | 3: MD* | 4: CDR | ⇄ |
| 2: MD* | 3: TV (or DBS**) | 4: CDR | ⇄ |
| (back to the beginning) | | | |

When “DIGITAL IN 1 (DGTL IN COAX)” is set to “TV” or “DBS”**

| | | | |
|-------------------------|--------|--------|---|
| 2: CD | 3: DVD | 4: CDR | ⇄ |
| 2: CD | 3: DVD | 4: MD* | ⇄ |
| 2: CD | 3: MD* | 4: CDR | ⇄ |
| 2: MD* | 3: DVD | 4: CDR | ⇄ |
| (back to the beginning) | | | |

When “DIGITAL IN 1 (DGTL IN COAX)” is set to “CDR”

| | | | |
|-------------------------|------------------|--------|---|
| 2: CD | 3: TV (or DBS**) | 4: DVD | ⇄ |
| 2: CD | 3: TV (or DBS**) | 4: MD* | ⇄ |
| 2: CD | 3: MD* | 4: DVD | ⇄ |
| 2: MD* | 3: TV (or DBS**) | 4: DVD | ⇄ |
| (back to the beginning) | | | |

When “DIGITAL IN 1 (DGTL IN COAX)” is set to “MD”**

| | | | |
|-------------------------|------------------|--------|---|
| 2: CD | 3: TV (or DBS**) | 4: CDR | ⇄ |
| 2: CD | 3: TV (or DBS**) | 4: DVD | ⇄ |
| 2: CD | 3: DVD | 4: CDR | ⇄ |
| 2: DVD | 3: TV (or DBS**) | 4: CDR | ⇄ |
| (back to the beginning) | | | |

* When connecting an MD recorder to the digital input terminal, change the source name to “MD” from “TAPE” (see page 21).

** If you have changed the source name from “TV” to “DBS,” “DBS” appears (see page 21).

For RX-7030VBK:

As you set the components connected to the digital coaxial terminal (DIGITAL IN 1), the optical terminals (DIGITAL IN 2 – 4) will be automatically fixed to connect the components listed below.

When “DIGITAL IN 1 (DGTL IN COAX)” is set to “DVD”

2: CD 3: TV (or DBS*) 4: CDR

When “DIGITAL IN 1 (DGTL IN COAX)” is set to “CD”

2: DVD 3: TV (or DBS*) 4: CDR

When “DIGITAL IN 1 (DGTL IN COAX)” is set to “TV” or “DBS”*

2: DVD 3: CD 4: CDR

When “DIGITAL IN 1 (DGTL IN COAX)” is set to “CDR”

2: DVD 3: CD 4: TV (or DBS*)

* If you have changed the source name from “TV” to “DBS,” “DBS” appears (see page 21).

Setting the Component Video Input

When you use the component video inputs for connecting the DVD player and/or DBS tuner, register the type of input jacks. If you have not selected appropriate video input jacks, the AV COMPU LINK remote control system cannot operate properly. (See page 42.)

■ **For the DVD player—VIDEO IN DVD**

Select one of the following:

COMPNT: Select when connecting the DVD player to the component video input jacks.

S/C: Select when connecting the DVD player to the composite video or S-video input jacks.

■ **For the DBS tuner—VIDEO IN DBS**

Select one of the following:

COMPNT: Select when connecting the DBS tuner to the component video input jacks.

S/C: Select when connecting the DBS tuner to the composite video or S-video input jacks.

Memorizing the Volume Level for Each Source

This unit memorizes some settings separately for each source. In addition, you can store the volume level for each source with the other memorized settings—One Touch Operation.

■ **One Touch Operation—ONE TOUCH OPE**

Select one of the following:

ON: Select to store the volume level separately for each source. (The ONE TOUCH OPERATION indicator lights up on the display.)

This receiver memorizes the volume level—

- when you change the source, or
- when you change the source name.

OFF: Select this not to store the volume level.

To recall the volume level

With the ONE TOUCH OPERATION indicator lit, the volume level for the currently selected source is recalled when the source is selected.

To cancel the One Touch Operation

Set One Touch Operation to “OFF” so that the ONE TOUCH OPERATION indicator goes off.

Adjusting Sound

You can make sound adjustment to your preference after completing basic setting.

Basic Setting Items

- On the following pages, you can adjust the items listed below:
- You can adjust only the items applicable to the current sound mode.
 - If Analog Direct is in use, you cannot make any sound adjustments.

| Items | To do | See page |
|--------------------------------|--|----------|
| DIGITAL EQ | Adjust equalizer pattern. | 32 |
| SUBWFR LVL | Adjust the subwoofer output level. | 32 |
| FRONT L LVL | Adjust the left front speaker output level. | 32 |
| FRONT R LVL | Adjust the right front speaker output level. | 32 |
| CENTER LVL | Adjust the center speaker output level. | 32 |
| SURR L LVL | Adjust the left surround speaker output level. | 32 |
| SURR R LVL | Adjust the right surround speaker output level. | 32 |
| SBACK LVL | Adjust the surround back speaker output level. | 32 |
| EFFECT*¹ | Adjust the DAP effect level. | 33 |
| ROOMSIZE*¹ | Select the room size for your virtual listening room. | 33 |
| LIVENESS*¹ | Select the liveness level for your virtual listening room. | 33 |
| CTR TONE | Make the center tone soft or sharp. | 33 |
| PANORAMA*² | Add “wraparound” sound effect with side-wall image. | 33 |
| CNTR WIDTH*² | Adjust the center channel localization between the center speaker and the left/right front speakers. | 33 |
| DIMENSION*² | Adjust sound localization position. | 33 |
| CNTR GAIN*³ | Adjust sound localization of the center channel. | 33 |

Notes:

- *¹ Adjustable when the DAP mode is in use.
- *² Adjustable when Pro Logic II Music is in use.
- *³ Adjustable when Neo:6 Music is in use.

Basic Procedure

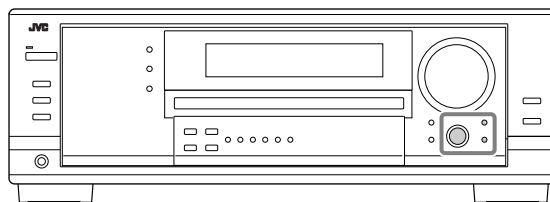

Before you start, remember...

There is a time limit in doing the following steps. If the setting is canceled before you finish, start from step 1 again.

Ex. When adjusting the subwoofer level to “- 3”.

1. Press ADJUST.

The last selected item appears on the display.



2. Turn MULTI JOG until an item you want appears on the display.

- In this example, select “SUBWFR LVL.” For available items, see the list to the left.



3. Press in MULTI JOG (PUSH SET).

The current setting (or level) for the selected item appears on the display.



4. Turn MULTI JOG to select a setting you want or to make an adjustment as you like.



5. Press EXIT.

6. Repeat steps 2 to 5 to set other items if necessary.

7. Press EXIT.

The source indication resumes on the display.

Adjusting the Equalization Patterns

You can adjust the equalization patterns to your preference.

- Once you have made adjustment, it is memorized for each source.

■ **Equalization adjustment—DIGITAL EQ**

You can adjust five frequency (**63 Hz, 250 Hz, 1 kHz, 4 kHz, 16 kHz**) within the range of **-8 dB to +8 dB** ("**0 dB**" is the initial setting) in 2 dB steps.

- When adjustment is made, the DIGITAL EQ indicator lights up on the display.

To flat the equalization pattern, set all the frequency to "0 dB" in step 4 of "Basic Procedure" (on page 31). The DIGITAL EQ indicator goes off from the display.

Notes:

- When Analog Direct is in use, Digital Equalization patterns are not available.
- The Digital Equalization affects the front speaker sounds only.

You can also use the remote control for equalization adjustment.

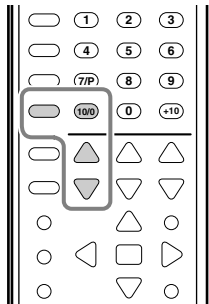

- Press SOUND.**
The 10 keys are activated for sound adjustments.
- Press DIGITAL EQ (Equalization) repeatedly to select the center frequency you want to adjust.**
 - Each time you press the button, the center frequency with its current level appear on the display
- Press LEVEL + or - repeatedly to adjust the level of the center frequency.**
The DIGITAL EQ indicator lights up on the display.
 - The frequency level changes from -8 dB to +8 dB in 2 dB steps.
- Repeat steps 2 and 3 to adjust the other center frequency.**

Adjusting the Speaker Output Levels

You can adjust the speaker output levels. The test tone comes out of each speaker except subwoofer to check the output level balance when using the Surround mode.

- Once you have made an adjustment, it is memorized for each source.

■ **Adjustable speakers**

You can adjust the following speakers' output levels within the range of **-10 dB to +10 dB** ("**0 dB**" is the initial setting):

| | |
|---------------------|---|
| SUBWFR LVL : | Select to adjust the subwoofer output level. |
| FRONT L LVL: | Select to adjust the left front speaker output level. |
| FRONT R LVL: | Select to adjust the right front speaker output level. |
| CENTER LVL: | Select to adjust the center speaker output level. |
| SURR L LVL: | Select to adjust the left surround speaker output level. |
| SURR R LVL: | Select to adjust the right surround speaker output level. |
| SBACK LVL: | Select to adjust the surround back speaker output level. |

Notes:

- If you have selected "NO" or "NONE" for a speaker (see page 27), the output level for the corresponding speaker is not adjustable.
- The center speaker, and left/right surround speakers' output levels are adjustable for DVD MULTI playback mode, even though "NONE" is selected for the speaker settings.
- Speaker output levels (except the subwoofer output level) are not adjustable when Analog Direct is in use. To adjust subwoofer output level, see page 19.

You can also use the remote control for adjusting the speaker output level.

When using the remote control, you can make an adjustment while listening to test tone.

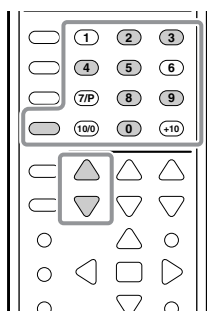

1. Press SOUND.

The 10 keys are activated for sound adjustments.

2. Press TEST to check if you can hear the sounds through all the speakers at equal level.

Test tone comes out of the speakers in the following order.

- No test tone comes out of the deactivated speakers and the subwoofer.

FRNT L (Left front speaker) → CENTER (Center speaker) →
FRNT R (Right front speaker) →
SURR R (Right surround speaker) →
S BACK (surround back speaker) →
SURR L (Left surround speaker) → (Back to the beginning)

3. Select a speaker you want to adjust.

- To select the left front speaker, press FRONT•L.
- To select the center speaker, press CENTER.
- To select the right front speaker, press FRONT•R.
- To select the right surround speaker, press SURR•R.
- To select the surround back speaker, press SURR BACK.
- To select the left surround speaker, press SURR•L.

4. Press LEVEL + or LEVEL – to adjust the speaker output level (–10 dB to +10 dB).

5. Repeat steps 3 and 4 to adjust the other speaker's output levels.

6. Press TEST again to stop the test tone.

Adjusting the Sound Parameters for the Surround and DSP Modes

You can adjust the Surround and DSP sound parameters to your preference.

- When center speaker is set to “NONE,” CTR TONE, CNTR WIDTH, and CNTR GAIN are not available.

■ Adjustable parameters

You can adjust the following parameters:

For Surround, DAP, and All Channel Stereo modes (when the center speaker is connected)

- This setting is common to all surround modes, and is memorized separately for DSP modes.

CTR TONE: Adjust the center tone. As the number increases, the dialogue becomes clearer so that the human voices change from soft to sharp. (Normally select “3 (initial setting).” Adjustable range: 1 to 5)

For DAP modes

- Once you have made an adjustment, it is memorized for each DAP mode.

EFFECT: Adjust the DAP effect level. As the number increases, the DAP effect becomes stronger. (Normally select “3 (initial setting).” Adjustable range: 1 to 5)

ROOMSIZE: Adjust the virtual room size. As the number increases, the interval between reflections increases so that you will feel as if you were in a larger room. (Normally select “3 (initial setting).” Adjustable range: 1 to 5)

LIVENESS: Adjust the liveness effect. As the number increases, the attenuation level of reflections over time decreases so that acoustics change from “Dead” to “Live.” (Normally select “3 (initial setting).” Adjustable range: 1 to 5)

For Pro Logic II Music only

PANORAMA: Select “ON” to add “wraparound” sound effect with side-wall image. (Initial setting: “OFF”)

CNTR WIDTH: Adjust the center channel localization between the center speaker and the left/right speakers. As the number increases, the center channel sound moves toward the left and right speakers. (Normally select “3 (initial setting).” Adjustable range: OFF and 1 to 7)

DIMENSION: Adjust sound localization position. As the number increases, the sound localization moves towards forward from backward. (Normally select “4 (initial setting).” Adjustable range: 1 to 7)

For Neo:6 Music only

CNTR GAIN: Adjust the sound localization of the center channel. As the number increases, center channel will be localized clearly. (Normally select “0.2 (initial setting).” Adjustable range: 0 to 0.5)

Using the Surround Modes

This unit activates a variety of Surround modes automatically. The basic settings and adjustments stored (see pages 25 to 33) are applied.

Reproducing Theater Ambience

In a movie theater, many speakers are located on the walls to reproduce impressive multi-surround sounds, reaching you from all directions.

With these many speakers, sound localization and sound movement can be expressed.

Surround modes built in this receiver can create almost the same surround sounds as you can feel in a real movie theater—with only five to seven speakers (plus subwoofer).

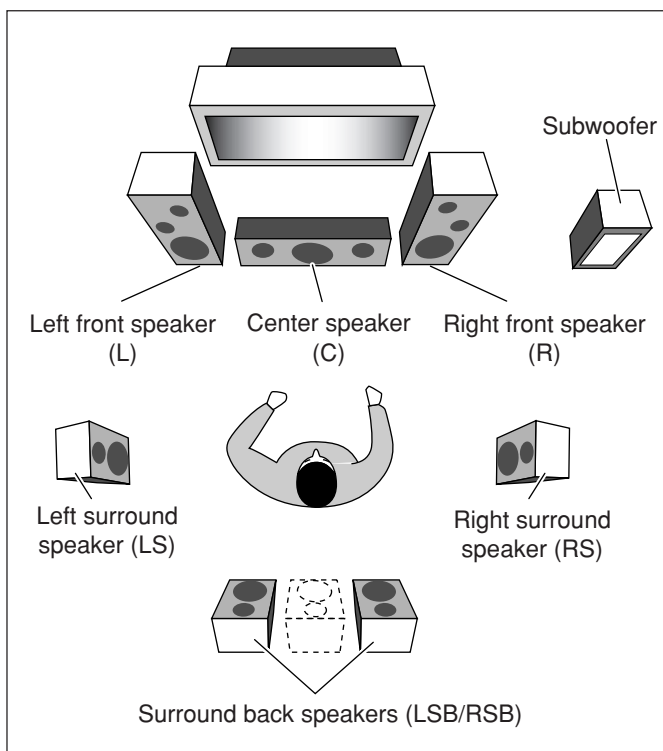
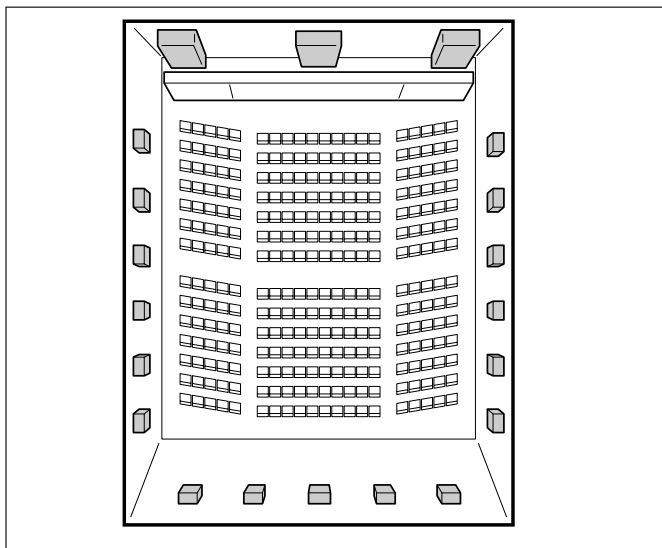

Introducing the Surround Modes

Dolby Digital*¹

Dolby Digital is a digital signal compression method, developed by Dolby Laboratories, and enables multi-channel encoding and decoding (1ch up to 5.1ch).

- When Dolby Digital signal is detected through the digital input, the  indicator lights up on the display.

Dolby Digital 5.1CH

Dolby Digital 5.1CH (DOLBY D) encoding method records and digitally compresses the left front channel, right front channel, center channel, left surround channel, right surround channel, and LFE channel signals (total 6 channels, but the LFE channel is counted as 0.1 channel. Therefore, called 5.1 channel).

Dolby Digital enables stereo surround sounds, and sets the cutoff frequency of the surround treble at 20 kHz, compared to 7 kHz for Dolby Pro Logic. As such, the sound movement and “being-there” feeling are enhanced much more than Dolby Pro Logic.

Dolby Digital EX

Dolby Digital EX (DOLBY D EX) is a digital surround encoding format that adds the third surround channels, called “surround back.”

Compared to the conventional Dolby Digital 5.1CH, these newly added surround back channels can reproduce more detailed movements behind you while viewing the video software. In addition, surround sound localization will become more stable.

- You can use Virtual 6.1-channel surround when playing back Dolby Digital EX software without connecting the surround back speakers. This surround reallocates the surround back channel to the surround speakers so that you can still feel the great surround effect from behind.

The VIRTUAL SB (Surround Back) indicator lights up on the display.

Dolby Pro Logic

Dolby Surround encoding format records the left front channel, right front channel, center channel, and surround channel (monaural) signals into 2 channels.

The Dolby Pro Logic (PRO LOGIC) decoder built in this receiver decodes these 2 channel signals into 4 original channel signals (plus subwoofer)—matrix-based multi-channel reproduction.

- When Dolby Pro Logic is activated, the  PRO LOGIC indicator lights up on the display.

Dolby Pro Logic II

Dolby Pro Logic II is a multi-channel playback format to convert 2-channel software into 5-channel (plus subwoofer). The matrix-based conversion method used for Dolby Pro Logic II makes no limitation for the cutoff frequency of the surround treble and enables stereo surround sound.

- This receiver provides two types of Dolby Pro Logic II modes—**Pro Logic II Movie** (PLII MOVIE) and **Pro Logic II Music** (PLII MUSIC).

When Dolby Pro Logic II is activated, the  **PRO LOGIC II** indicator lights up on the display.

PLII MOVIE: Suitable for playing any Dolby Surround encoded software. You can enjoy a sound field very close to the one created with discrete 5.1-channel sounds.

PLII MUSIC: Suitable for playing any 2-channel stereo software. You can enjoy wide and deep sounds.

DTS*2

DTS is another digital signal compression method, developed by Digital Theater Systems, Inc., and enables multi-channel encoding and decoding (1ch up to 6.1ch).

- When DTS signal is detected through the digital input, the  indicator lights up on the display.

DTS Digital Surround

DTS Digital Surround (DTS) is another discrete 5.1 channel digital audio format available on CD, LD, and DVD software.

Compared to Dolby Digital, the DTS Digital Surround format has a lower audio compression rate which enables it to add breadth and depth to the sounds reproduced. As such, DTS Digital Surround features natural, solid, and clear sound.

- When EX/ES setting is set to “ON,” DTS Neo:6 (DTS NEO:6) is applied while playing back multi-channel DTS software. It creates the same surround ambience as 6.1-channel software does.

DTS Extended Surround (DTS-ES)

DTS-ES is another multi-channel digital encoding format.

It greatly improves the 360-degree surround impression and space expression by adding the third surround channel—surround back channel.

DTS-ES includes two signal formats with different surround signal recording methods—**DTS-ES Discrete 6.1ch** (ES DSCRETE) and **DTS-ES Matrix 6.1ch** (ES MATRIX).

DTS-ES Discrete 6.1ch has been designed to encode (and decode) a 6.1-channel signal discretely to avoid interference with each channel.

DTS-ES Matrix 6.1ch has been designed to add an extra surround channel to DTS Digital Surround 5.1-channel. By using a matrix encoding/decoding method, an additional “surround back” channel signal is encoded (and decoded) in both the left and right surround channel signals.

- You can use Virtual 6.1-channel surround when playing back DTS-ES software without connecting the surround back speakers. This surround reallocates the surround back channel to the surround speakers so that you can still feel the great surround effect from behind.
The VIRTUAL SB (Surround Back) indicator lights up on the display.

DTS 96/24

In recent years, there has been increasing interest in higher sampling rates both for recording and for reproducing at home. Higher sampling rates allow wider frequency range and greater bit depths provide extended dynamic range.

DTS 96/24 is a multi-channel digital signal format (fs 96 kHz/24 bits) introduced by Digital Theater Systems, Inc. to deliver “better-than-CD sound quality” into the home.

- When DTS 96/24 signal is detected, the 96/24 indicator lights up. You can enjoy its 5.1-channel sound with full-quality.

DTS Neo:6

DTS Neo:6 is another conversion method to create 6-channel (plus subwoofer) from analog/digital 2-channel software by using the high precision digital matrix decoder used for DTS-ES Matrix 6.1ch.

When one of Neo:6 modes is activated, the NEO:6 indicator lights up on the display.

- This receiver provides the following DTS NEO:6 modes—**Neo:6 Cinema** (NEO:6CINMA) and **Neo:6 Music** (NEO:6MUSIC).

NEO:6CINMA: Suitable for playing movies. You can get the same atmosphere with 2-channel software as with 6.1-channel software. It is also effective for playing software encoded with conventional surround formats.

NEO:6MUSIC: Suitable for playing music software. The front channel signals bypass the decoder (resulting in no loss of sound quality) and the surround signals transmitted through the other speakers expand the sound field naturally.

What is Dual Mono?

Dual Mono can be easily understood when you think of the bilingual broadcast or the MTS (Multichannel Television Sound) used for TV programs (however, the Dual Mono format is not identical with those analog formats).

This format is now adopted in Dolby Digital, DTS, and so on. It allows two independent channels (called main channel and sub-channel) to be recorded separately.

- When Dual Mono signal is detected, the DUAL indicator lights up. You can select either channel you want to listen to (see page 29).

When using the Surround mode, the sounds come out of the activated speakers which the Surround mode requires.

- **If the surround speakers and center speaker are set to “NONE” in the speaker setting, JVC’s original 3D-PHONIC processing (which has been developed to create the surround effect through the front speakers only) is used.**
The 3D-PHONIC indicator lights up on the display.

*1 *Manufactured under license from Dolby Laboratories. “Dolby”, “Pro Logic”, and the double-D symbol are trademarks of Dolby Laboratories.*

*2 *“DTS”, “DTS-ES Extended Surround” and “Neo:6” are trademarks of Digital Theater Systems, Inc.*

Surround Modes Applicable to the Various Software

Available Surround modes vary depending on the speaker settings and the incoming signals.

The table below shows the relation of the Surround modes and the incoming signals (with the surround back speakers and EX/ES setting).

- The numbers inside the parentheses following the incoming signal type indicate the number of the front channels and that of the surround channels. For example, (3/2) indicates that the signals are encoded with three front signals (left/right/center) and two (stereo) surround signals.

| Incoming Signal Type | Surround Back Channel Setting | EX/ES Setting | Available Surround Mode |
|--|-------------------------------|---|---|
| Dolby Digital EX | 2SPK/1SPK | AUTO/ON | DOLBY D EX |
| | | OFF | DOLBY D |
| | NONE | AUTO/ON | DOLBY D (VIRTUAL SB)* ¹ |
| | | OFF | DOLBY D |
| Dolby Digital (3/2, 2/2) | 2SPK/1SPK | AUTO | DOLBY D |
| | | ON | DOLBY D EX |
| | | OFF | DOLBY D |
| | NONE | Not available | DOLBY D |
| | | | |
| Dolby Digital (3/1, 2/1) | 2SPK/1SPK | AUTO/ON/OFF | DOLBY D |
| | NONE | Not available | DOLBY D |
| Dolby Digital (1/0, 3/0) | 2SPK/1SPK/NONE | Not available | DOLBY D |
| Dolby Digital (Dual Mono) | 2SPK/1SPK/NONE | Not available | DUAL MONO |
| DTS-ES Discrete 6.1ch | 2SPK/1SPK | AUTO/ON | ES DSCRETE |
| | | OFF | DTS |
| | NONE | AUTO/ON | DTS (VIRTUAL SB)* ¹ |
| DTS-ES Matrix 6.1ch DTS-ES 96/24 Matrix | 2SPK/1SPK | AUTO/ON | ES MATRIX* ² |
| | | OFF | DTS |
| | NONE | AUTO/ON | DTS (VIRTUAL SB)* ¹ * ² |
| | | OFF | DTS |
| DTS, DTS 96/24 (3/2, 2/2) | 2SPK/1SPK | AUTO | DTS |
| | | ON | DTS NEO:6* ² |
| | | OFF | DTS |
| | NONE | Not available | DTS |
| | | | |
| DTS (3/1, 2/1) | 2SPK/1SPK | AUTO/ON/OFF | DTS |
| | NONE | Not available | DTS |
| DTS (1/0, 3/0) | 2SPK/1SPK/NONE | Not available | DTS |
| DTS (Dual Mono) | 2SPK/1SPK/NONE | Not available | DUAL MONO |
| Incoming Signal Type | | Available Surround Mode | |
| Analog/PCM/Dolby Digital (2/0)/DTS (2/0) | | PL II MOVIE / PL II MUSIC / PRO LOGIC / NEO:6 CINMA / NEO:6 MUSIC | |
| DVD MULTI | | None | |

3D HEADPHONE Mode—3D H PHONE

You can also enjoy the Surround modes through the headphones.

If you press SURROUND when the front speakers 1 and 2 are both deactivated, 3D HEADPHONE mode (3D H PHONE) is activated without respect to the type of software played back. "3D H PHONE" appears on the display and the DSP and HEADPHONE indicators also light up.

*¹ Virtual 6.1-channel surround

If you have connected (and activated) the surround speakers, you can use Virtual 6.1-channel surround when playing back Dolby Digital EX or DTS-ES software without connecting the surround back speakers. This surround reallocates the surround back channel to the surround speakers so that you can still feel the great surround effect from behind. The VIRTUAL SB (Surround Back) indicator lights up on the display.

Activating the Surround Modes

Available Surround modes vary depending on the speaker settings and the incoming signals. (See page 36.)

Activating one of the Surround modes for a source automatically recalls the memorized settings and adjustments (see pages 25 to 33.)

You can also use the buttons on the remote control for the same functions.

Activating the EX/ES setting

For multi-channel digital software, you can activate the EX/ES (7.1-channel) reproduction mode.

- Once you have set EX/ES (7.1-channel) reproduction mode, it is stored in memory and will be called up whenever you activate the Surround mode which the memorized EX/ES (7.1-channel) reproduction mode can be applied to.

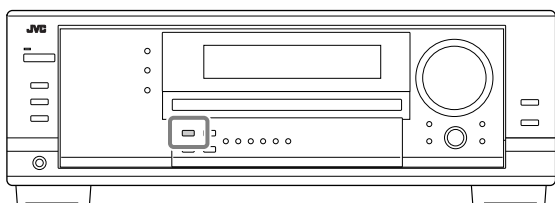

Press EX/ES to select an appropriate setting for your enjoyment.

The currently selected EX/ES (7.1-channel) reproduction mode appears on the display.

- Each time you press the button, it changes as follows:

EX/ES AUTO*: According to the incoming signal, an appropriate Surround mode is applied.

- For Dolby Digital EX and DTS-ES, EX/ES (7.1-channel) reproduction is applied.
- For 5.1-channel (or less) encoded software, 5.1-channel reproduction is applied.

EX/ES ON*: Select to apply EX/ES (7.1-channel) reproduction to both 5.1-channel and 6.1-channel encoded software.

EX/ES OFF: Select to cancel the EX/ES (7.1-channel) reproduction.

* If the surround back speakers are not connected or deactivated, Virtual 6.1-channel surround is applied.

Notes:

- When Surround mode is deactivated, pressing EX/ES will activate an appropriate Surround mode for the current source.
- When an analog or digital 2-channel source is playing, you can adjust the EX/ES (7.1-channel) reproduction mode and store the setting, but it will not affect the current source.
- When the source is one to which the EX/ES (7.1-channel) reproduction cannot be applied, you can adjust the setting and store in memory, but reproduction channels will remain unchanged.

Activating the Surround Modes

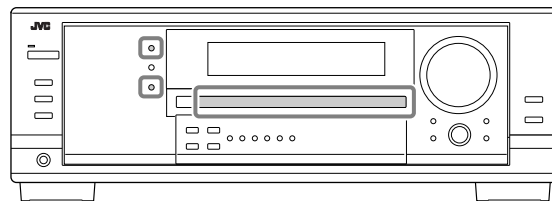

1. Select and play any source other than “DVD MULTI.”

- Make sure you have selected the analog or digital input mode.
- Surround modes are not valid for DVD MULTI playback mode.

2. Press SURROUND to activate the Surround mode.

- For multi-channel digital software (except 2-channel and Dual Mono software), incoming signals are automatically detected and the appropriate surround mode is activated (see page 36 for details).



Ex. When “DOLBY D” is activated.

- If the EX/ES (7.1-channel) reproduction mode has been set to “AUTO” or “ON,” one of the EX/ES (7.1-channel) reproduction modes will be activated (see the left column).

- For analog sources and digital 2-channel software, you can select one of the following Surround modes. Each time you press SURROUND, Surround modes change as follows:

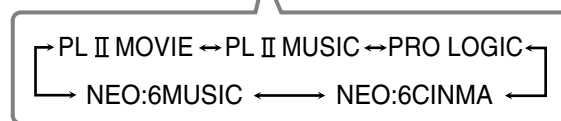

- For Dual Mono software, you can select the channel you listen to. (See page 29.)

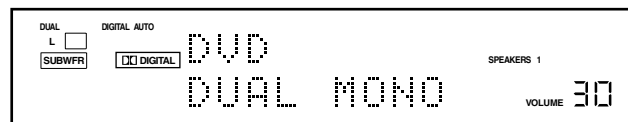

To adjust the speaker output level, see pages 32 and 33.

To cancel the Surround mode

Press SURROUND/DSP OFF (or SURR/DSP OFF on the remote control). “SURR OFF” appears on the display.

Using the DSP Modes

This unit activates a variety of DSP modes automatically. The basic settings and adjustments stored (see pages 25 to 33) are applied automatically.

Reproducing the Sound Field

The sound heard in a concert hall, club, etc. consists of direct sound and indirect sound—early reflections and reflections from behind. Direct sounds reach the listener directly without any reflection. On the other hand, indirect sounds are delayed by the distances of the ceiling and walls. These direct sounds and indirect sounds are the most important elements of the acoustic surround effects. The DSP modes can create these important elements, and give you a real “being there” feeling.

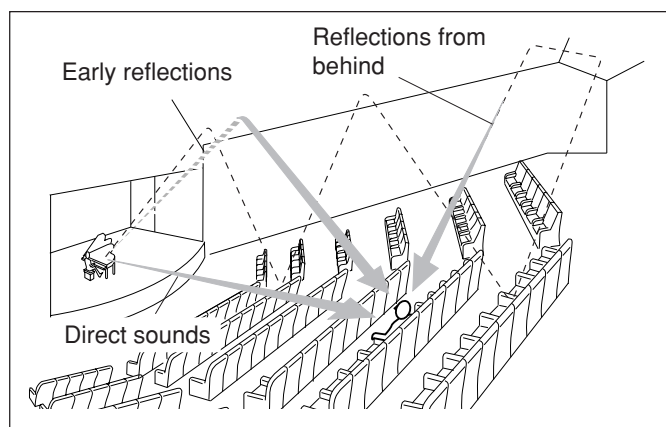

Introducing the DSP Modes

The DSP modes include the following modes—

- DAP (Digital Acoustic Processor) modes (HALL 1, HALL 2, LIVE CLUB, DANCE CLUB, PAVILION, THEATER 1, THEATER 2)
- ALL CH STEREO
- MONO FILM

3D HEADPHONE Mode

You can also enjoy the DSP effect (except All Channel Stereo mode) through the headphones.

If you press DSP when the front speakers 1 and 2 are both deactivated, 3D HEADPHONE mode is activated without respect to the type of software played back. “3D H PHONE” appears on the display and the DSP and HEADPHONE indicators also light up.

To use the DSP modes, press DSP so that the DSP modes change as follows.

The DSP indicator also lights up on the display.

| | | |
|--|-------------|--------------|
| → HALL 1 | → HALL 2 | → LIVE CLUB |
| → DANCE CLUB | → PAVILION | → ALL STEREO |
| → THEATER 1 | → THEATER 2 | → MONO FILM |
| → (Back to the beginning) | | |
| <input type="checkbox"/> : Suitable for audio sources <input type="checkbox"/> : Suitable for video sources | | |

DAP modes

You can use the following DAP modes in order to reproduce a more acoustic sound field in your listening room.

| | |
|--------------------|---|
| HALL 1: | Reproduces the spatial feeling of a large shoebox-shaped hall designed primarily for classical concerts. (Its seating capacity is about 2000.) |
| HALL 2: | Reproduces the spatial feeling of a large vineyard-shaped hall designed primarily for classical concerts. (Its seating capacity is about 2000.) |
| LIVE CLUB: | Reproduces the spatial feeling of a live music club with a low ceiling. |
| DANCE CLUB: | Reproduces the spatial feeling of a rocking dance club. |
| PAVILION: | Reproduces the spatial feeling of an exhibition hall with a high ceiling. |
| THEATER 1*: | Reproduces the spatial feeling of a large theater where the seating capacity is about 600. |
| THEATER 2*: | Reproduces the spatial feeling of a small theater where the seating capacity is about 300. |

* The built-in Dolby Pro Logic II decoder is activated when playing back 2-channel analog or digital source. The **PRO LOGIC II** indicator lights up.

When using the DAP mode, the sounds come out of all the connected and activated speakers.

- If surround speakers are set to “NONE” in the speaker setting, JVC’s original 3D-PHONIC processing (which has been developed to create the surround effect through the front speakers only) is used.

The 3D-PHONIC indicator lights up on the display.

ALL Channel Stereo mode

This mode can reproduce a larger stereo sound field using all the connected (and activated) speakers. **This mode cannot be used without activating the surround speakers.**

- If the front speakers are deactivated, "All Channel Stereo" cannot be selected.

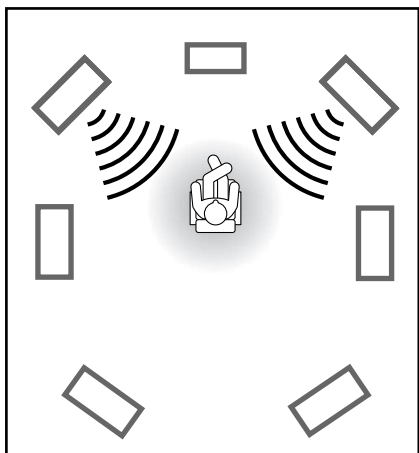

Sound reproduced from normal stereo

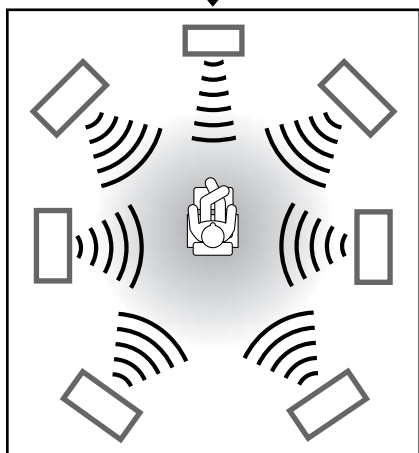

Sound reproduced from All Channel Stereo mode

Monaural Film

In order to reproduce a more acoustic sound field in your listening room while viewing monaural sound video software (analog and 2-channel digital signals), you can use this mode.

The surround effect will be added, and the sound localization of actor's words will be improved. **This mode cannot be used for multi-channel digital signals.**

When "MONO FILM" is used, sounds come out of all the connected (and activated) speakers.

- If incoming signals change from 2-channel digital signal to another digital signal type, "MONO FILM" is canceled and an appropriate Surround mode is activated.

Activating the DSP Modes

Activating one of the DSP modes for a source automatically recalls the memorized settings and adjustments (see pages 25 to 33.)

You can also use the buttons on the remote control for the same functions.

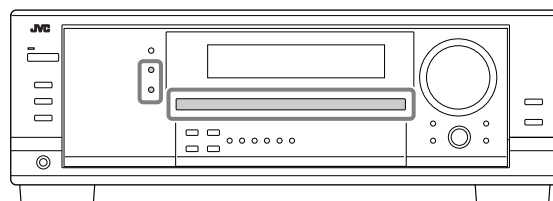

1. Select and play any sound source.
2. Press DSP repeatedly until the DSP mode you want appears on the display.

- Each time you press the button, the DSP modes change as follows:

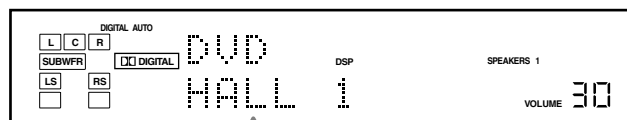

- | | | |
|---------------------------|-------------|---------------|
| → HALL 1 | → HALL 2 | → LIVE CLUB |
| → DANCE CLUB | → PAVILION | → ALL STEREO* |
| → THEATER 1 | → THEATER 2 | → MONO FILM** |
| → (Back to the beginning) | | |

* When surround speakers are set to "NONE," you cannot select "ALL STEREO."

** When multi-channel signals come in, you cannot select "MONO FILM."

Note:

When the surround speakers are deactivated, the 3D-PHONIC processing is applied to the DSP modes (the 3D-PHONIC indicator also lights up).

To cancel the DSP modes

Press SURROUND/DSP OFF (or SURR/DSP OFF on the remote control). "SURR OFF" appears on the display.

- When the front speakers are deactivated, "HEADPHONE" will appear.

Using the DVD MULTI Playback Mode

This receiver provides the DVD MULTI playback mode for reproducing the analog discrete output mode of the DVD player.

Connection diagram

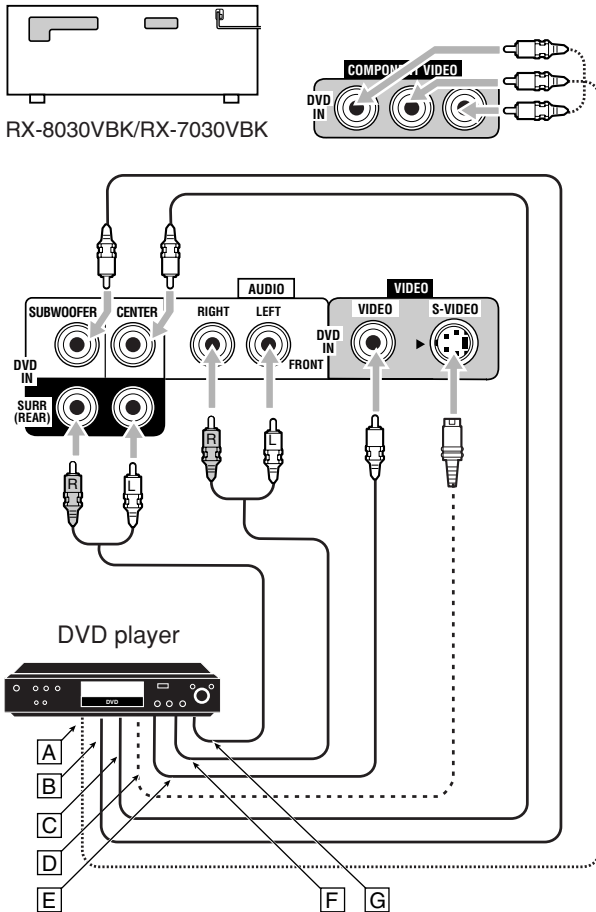

- A To component video output
- B To subwoofer output
- C To center channel audio output
- D To S-video output
- E To composite video output
- F To left/right front channel audio output
- G To left/right surround channel audio output

Note:

When connecting a DVD player to the component video input jacks, make the component video input setting correctly. See page 30 for details.

Activating the DVD MULTI Playback Mode

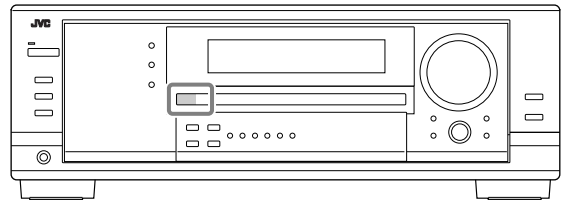

1. Press DVD MULTI so that "DVD MULTI" appears on the display.

The MULTI indicator also lights up.

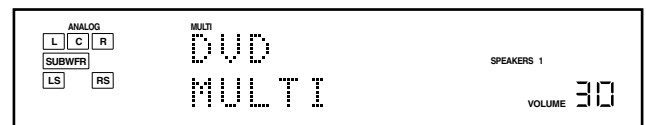

Note:

When you select "DVD MULTI" as the source to play, the Surround and DSP modes are canceled, and the SURROUND and DSP buttons do not work.

2. Select the analog discrete output mode on the DVD player, and start playing a DVD.

- Refer also to the manual supplied with the DVD player.

You can adjust Digital Equalization patterns and speaker output levels. See "Adjusting the Equalization Patterns" on page 32 for details.

Notes:

- Midnight Mode is not available for DVD MULTI playback mode (see page 20).
- When using a headphones, you can listen to the front channels (left and right) only.

COMPU LINK Remote Control System

The COMPU LINK remote control system allows you to operate JVC's audio components through the remote sensor on the receiver.

To use this remote control system, you need to connect JVC's audio components through the COMPU LINK (SYNCHRO) jacks (see below) in addition to the connections using cables with RCA pin plugs (see pages 12 and 13).

- Make sure that the AC power cords of these components are unplugged before connection. Plug the AC power cords only after all connections are complete.

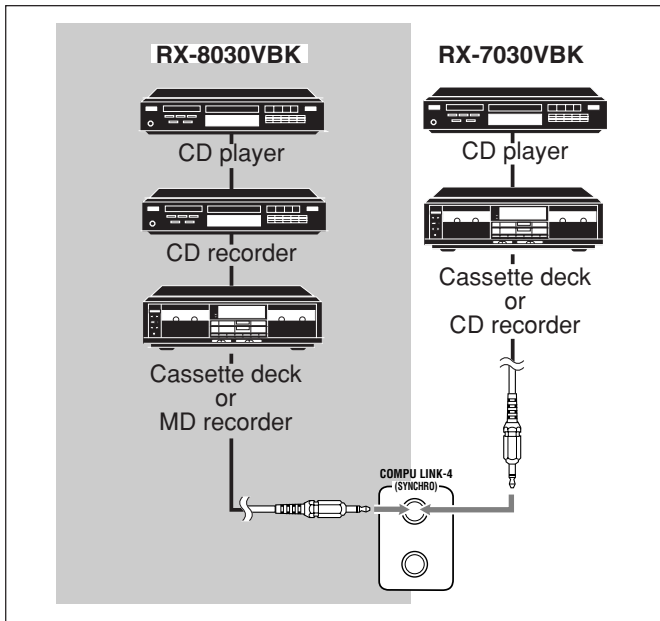

Notes:

- There are four versions of COMPU LINK remote control system. This receiver is equipped with the fourth version—COMPU LINK-4. This version is added systematic operations with the CD recorder to the previous version—COMPU LINK-3.
- If your audio component has two COMPU LINK jacks, you can use either one. If it has only one COMPU LINK jack, connect it so that it is the last item in the series of components.
- To operate the target component using the COMPU LINK remote control system, set the source name correctly if required. (See page 21.)
- Refer also to the manuals supplied with your audio components.

This remote control system allows you to use four functions listed below.

Remote Control through the Remote Sensor on the Receiver

You can control the connected audio components through the remote sensor on the receiver using this remote control. Aim the remote control directly at the remote sensor on the receiver. For details, see pages 44 and 45.

Automatic Source Selection

When you press the play (▶) button on a connected component or on its own remote control, the receiver automatically turns on and changes the source to the component. On the other hand, if you select a new source on the receiver or on the remote control, the selected component begins playing immediately. In both cases, the previously selected source continues playing without sound for a few seconds.

- For RX-7030VBK: You cannot use the COMPU LINK remote control system to operate the MD recorder.

Automatic Power On/Off (Standby)—only possible with the COMPU LINK-3 and COMPU LINK-4

The connected components turn on and off (standby) along with the receiver.

When you turn on the receiver, one of the connected components will turn on automatically, depending on which component has been previously selected.

When you turn off the receiver, the connected components will turn off (standby).

Synchronized Recording

Synchronized recording means the cassette deck (or MD recorder) starts recording as soon as a CD begins playing.

To use synchronized recording, follow these steps:

1. Put a tape in the cassette deck (or an MD in the MD recorder), and a disc in the CD player.
2. Press the record (●) button and the pause (II) button on the cassette deck (or MD recorder) at the same time.

This puts the cassette deck (or MD recorder) into recording pause.

If you do not press the record (●) button and pause (II) button at the same time, the synchronized recording feature will not operate.

3. Press the play (▶) button on the CD player.

The source changes on the receiver, and as soon as play starts, the cassette deck (or MD recorder) starts recording. When the play ends, the cassette deck (or MD recorder) enters recording pause, and stops about 4 seconds later.

Notes:

- During synchronized recording, the selected source cannot be changed.
- If the power of any component is shut off during synchronized recording, the COMPU LINK remote control system may not operate properly. In this case, you must start again from the beginning.

AV COMPU LINK Remote Control System

The AV COMPU LINK remote control system allows you to operate JVC's video components (TV, VCR, and DVD player) through the receiver.

This receiver is equipped with the AV COMPU LINK-III, which adds a function to the previous version in order to operate JVC's video components through the video components terminals. To use this remote control system, connect the video components you want to operate, following the diagrams below and the procedure on the next page.

CONNECTIONS 1: AV COMPU LINK Connection

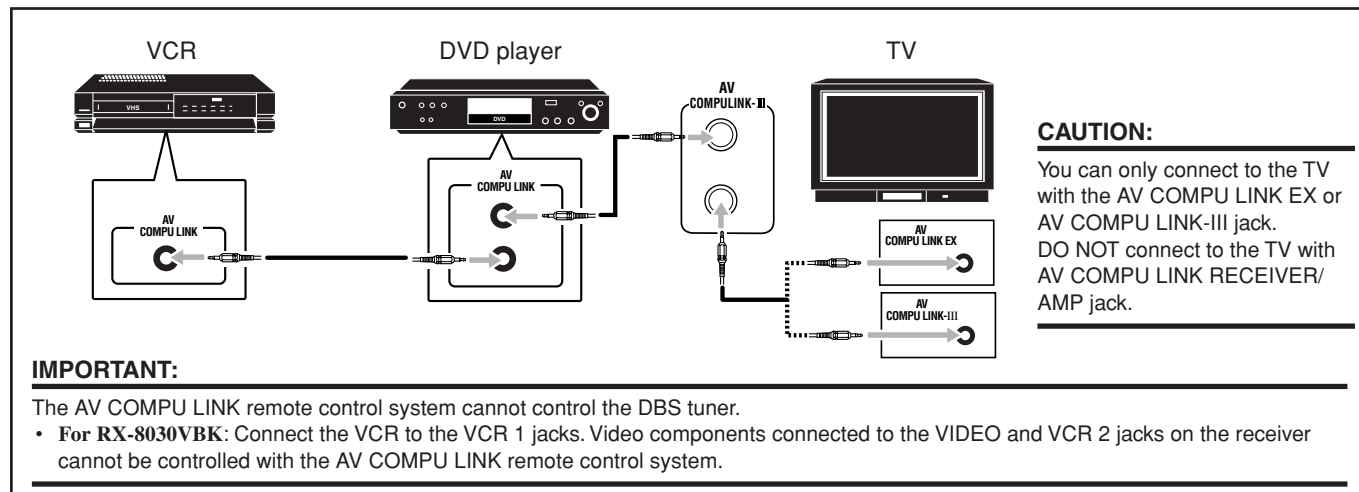

Notes:

- When connecting the receiver and a TV with the AV COMPU LINK EX terminal by using a component video cable, you cannot use automatic selection of TV's input mode (see page 43).
- When connecting only the VCR or DVD player to this receiver, connect it directly to the receiver using cables with the monaural mini-plugs.

CONNECTIONS 2: Video Cable Connection

This receiver is equipped with three types of the video terminals—S-video, composite video, and component video, and the signals coming into this receiver through one type of video jacks can output only through the jack of the same type. So you need to connect the VCR and/or DVD player to the TV using one of the following three ways:

- When using the AV COMPU LINK remote control system, set the component video input for the DVD player and the DBS tuner correctly (see "Setting the Component Video Input" on page 30); otherwise, the correct input for this receiver will not be selected on the TV.

| | |
|--------|--|
| CASE 1 | <p>When connecting the source equipment to the receiver through the S-video jacks, connect this receiver to the TV's Video Input 1 jack using S-video cables.</p> |
| CASE 2 | <p>When connecting the source equipment to the receiver through the composite video jacks, connect this receiver to the TV's Video Input 2 jack (composite video input) using composite video cables.</p> |
| CASE 3 | <p>When connecting the source equipment to the receiver through the component video jacks, connect this receiver to the TV's Video Input 2 jack (component video input) using component video cables.</p> |

1. **If you have already plugged your VCR , DVD player, TV and this receiver into the AC outlets, unplug their AC power cords first.**
2. **Connect your VCR, DVD player, TV and this receiver, using the cables with the monaural mini-plugs (not supplied).**
 - See “CONNECTIONS 1” on the previous page.
3. **Connect the audio input/output jacks on VCR, DVD player, TV and this receiver using the cables with RCA pin plugs.**
 - See pages 14 and 15.
4. **Connect the video input/output jacks on VCR, DVD player, TV and this receiver, using the cables with RCA pin plugs, S-video plug or component video plugs.**
 - See “CONNECTIONS 2” on the previous page.
5. **Plug the AC power cords of the components and the receiver into the AC outlets.**
6. **When turning on the TV for the first time after the AV COMPU LINK connection, turn the TV volume to the minimum using the TV volume control on the TV.**
7. **Turn on the connected components first, then turn on this receiver.**
 - When turning on the VCR, use the remote control supplied with this receiver.

The AV COMPU LINK remote control system allows you to use the five basic functions listed below.

Remote Control of the TV, DVD player, and VCR Using This Remote Control

See page 46 for details.

- Aim the remote control directly at the remote sensor on each target component.

One-Touch Video Play

Simply by inserting a video cassette without its safety tab into the VCR, you can enjoy the video playback without setting other switches manually. The receiver automatically turns on and changes the source to “VCR 1” (for RX-8030VBK) or “VCR” (for RX-7030VBK).

The TV automatically turns on and changes the input mode to the appropriate position so that you can view the playback picture.

When you insert a video cassette with its safety tab, press the play (▶) button on the VCR or on the remote control. So, you can get the same result.

One-Touch DVD Play

Simply by starting playback on the DVD player, you can enjoy the DVD playback without setting other switches manually.

- When the DVD player is connected through the analog input jacks on this receiver (and analog input is selected), the receiver automatically turns on and changes the source to “DVD” or “DVD MULTI.”
 - When the DVD player is connected through the digital input terminal on this receiver (and digital input is selected), the receiver automatically turns on and changes the source to “DVD.”
- The TV automatically turns on and changes the input mode to the appropriate position so that you can view the playback picture.

Automatic Selection of TV's Input Mode

- When you select “TV” as the source to play on the receiver, the TV automatically changes the input mode to the TV tuner so that you can watch TV.
- When you select any other video source other than “TV” as the source to play on the receiver, the TV automatically changes the input mode to the appropriate position (either Video Input 1 or Video Input 2) so that you can view the playback picture.

Notes:

- *When you select “TV” as the source on the receiver, you cannot see the menu on the TV screen since the AV COMPU LINK remote control system automatically changes the TV's input mode to the TV tuner.*
- *This function does not work when you connect this receiver and the TV with the AV COMPU LINK EX terminal using a component video cable. In this case, reconnect the TV referring to case 1 or case 2 on page 42.*

Automatic Power On/Off

The TV, VCR, and DVD player turn on and off along with the receiver.

When you turn on the receiver;

- If the previously selected source is “VCR 1” (for RX-8030VBK) or “VCR” (for RX-7030VBK), the TV and VCR will turn on automatically.
- If the previously selected source is “DVD” or “DVD MULTI,” the TV and DVD player will turn on automatically.
- If the previously selected source is any video source other than the above, only the TV will turn on automatically.

When you turn off the receiver, the TV, VCR and the DVD player will turn off.

Note:

If you turn off the receiver while recording on the VCR, the VCR will not turn off, but continue recording.

Operating JVC's Audio/Video Components

You can operate JVC's audio and video components with this receiver's remote control, since control signals for JVC's components are preset in the remote control.

Operating Audio Components

IMPORTANT:

To operate JVC's audio components using the supplied remote control:

- You need to connect JVC's audio components through the COMPU LINK (SYNCHRO) jacks (see page 41) in addition to the connections using cables with RCA pin plugs (see pages 11 to 13).
- Aim the remote control directly at the remote sensor on the receiver.
- If you use the buttons on the front panel to choose a source, the remote control will not operate that source. To operate a source with the remote control, the source must be selected using source selection buttons on the remote control.
- To operate the target component using the COMPU LINK remote control system, set the source name correctly if required. (See page 21.)
- Refer also to the manuals supplied with your components.

For RX-8030VBK:

- When you press one of the source selection buttons, the remote operation mode appears on the display window for about two hours.



| Buttons | Indications |
|-----------------------|-------------|
| FM/AM | TUNER |
| CD | CD |
| CDR | CDR |
| PHONO | PHONO |
| TAPE/MD | TAPE |
| CONTROL (repeatedly)* | |
| SOUND | SOUND |

* By pressing CONTROL repeatedly, you can select "VCR 1," "TAPE," "CDR" or "CDDSC" as the source.

- When you press one of the following buttons, the remote operation mode appears on the display window for about two hours.

| Buttons | Indications |
|------------|-------------|
| FRONT•L | FRL |
| FRONT•R | FRR |
| CENTER | CTR |
| SURR•L | SURRL |
| SURR•R | SURRR |
| SURR BACK | SBK |
| SUBWOOFER | S-WFR |
| DIGITAL EQ | EQ |

Tuner

You can always perform the following operations:

FM/AM: Alternate between FM and AM.

After pressing FM/AM, you can perform the following operations on a tuner:

- 1 – 10/0, +10: Select a preset channel number directly.
 For channel number 5, press 5.
 For channel number 15, press +10, then 5.
 For channel number 20, press +10, then 10/0.

TUNING UP/DOWN:

Tune into stations.

FM MODE: Change the FM reception mode.

Sound control section (Amplifier)

You can always perform the following operations:

SURROUND: Turn on and select Surround modes

DSP: Turn on and select DSP modes.

SURR/DSP OFF: Turn off Surround and DSP modes.

After pressing SOUND, you can perform the following operations:

FRONT•L then LEVEL +/-: Adjust the left front speaker output level.

FRONT•R then LEVEL +/-: Adjust the right front speaker output level.

CENTER then LEVEL +/-: Adjust the center speaker output level.

SURR•L then LEVEL +/-: Adjust the left surround speaker output level.

SURR•R then LEVEL +/-: Adjust the right surround speaker output level.

SURR BACK: Adjust the surround back speaker output level.

SUBWOOFER then LEVEL +/-: Adjust the subwoofer output level.

DIGITAL EQ then LEVEL +/-: Select the sound frequency bands and adjust its level.

TEST: Turn on or off test tone output.

BASS BOOST: Turn on or off Bass Boost.

Note:

After adjusting sounds, press the corresponding source selection button to operate your target source by using the 10 keys; otherwise, the 10 keys cannot be used for operating your target source.

CD player

After pressing CD, you can perform the following operations on a CD player:

▶: Start playing.
 ◀◀: Return to the beginning of the current (or previous) track.

▶▶: Skip to the beginning of the next track.

■: Stop playing.

||: Pause playing. To resume, press ▶.

- 1 – 10/0, +10: Select a track number directly.
 For track number 5, press 5.
 For track number 15, press +10, then 5.
 For track number 20, press +10, then 10/0.
 For track number 30, press +10, +10, then 10/0.

CD changer

For RX-8030VBK:

After selecting "CDDSC" by pressing CONTROL repeatedly, you can perform the following operations on a CD changer:

For RX-7030VBK:

After pressing CD DISC, you can perform the following operations on a CD changer:

- ▶: Start playing.
- ◀◀: Return to the beginning of the current (or previous) track.
- ▶▶: Skip to the beginning of the next track.
- : Stop playing or recording.
- ||: Pause playing. To resume, press ▶.
- 1 – 6, 7/P: Select the number of a disc installed in a CD changer.

After pressing CD, you can perform the following operations on a CD changer:

- 1 – 10/0, +10: Select a track number directly.
 - For track number 5, press 5.
 - For track number 15, press +10, then 5.
 - For track number 20, press +10, then 10/0.
 - For track number 30, press +10, +10, then 10/0.

Example:

- Selecting disc number 4, track number 12, and starting playback.

For RX-8030VBK:

1. Press CONTROL repeatedly until "CDDSC" appears on the display window, then press 4.
2. Press CD, then press +10, 2.

For RX-7030VBK:

1. Press CD DISC, then press 4.
2. Press CD, then press +10, 2.

If your CD changer is of 200-disc loading capability (except for XL-MC100 and XL-MC301),

you can do the following operations using the 10 keys after pressing CD.

1. Select a disc number.
2. Then select a track number (always enter two digits).
3. Start playback.

Examples:

- Selecting disc number 3, track number 2, and starting playback. Press 3, then, 0, 2, then ▶.
- Selecting disc number 10, track number 5, and starting playback. Press 1, 0, then, 0, 5, then ▶.
- Selecting disc number 105, track number 12, and starting playback. Press 1, 0, 5, then 1, 2, then ▶.

Turntable

After pressing PHONO, you can perform the following operations on a turntable:

- ▶: Start playing.
- : Stop playing.



CD recorder

For RX-8030VBK: After pressing CDR (or selecting "CDR" by pressing CONTROL repeatedly), you can perform the following operations on a CD recorder:

For RX-7030VBK: After pressing TAPE/CDR (or TAPE/CDR CONTROL), you can perform the following operations on a CD recorder:

- ▶: Start playing.
- ◀◀: Return to the beginning of the current (or previous) track.
- ▶▶: Skip to the beginning of the next track.
- : Stop playing or recording.
- ||: Pause playing. To resume, press ▶.
- 1 – 10/0, +10: Select a track number directly.
 - For track number 5, press 5.
 - For track number 15, press +10, then 5.
 - For track number 20, press +10, then 10/0.
 - For track number 30, press +10, +10, then 10/0.
- REC PAUSE: Enter recording pause by pressing this button. To start recording again, press this button then ▶.

Cassette deck

For RX-8030VBK: After pressing TAPE/MD (or selecting "TAPE" by pressing CONTROL repeatedly), you can perform the following operations on a cassette deck:

For RX-7030VBK: After pressing TAPE/CDR (or TAPE/CDR CONTROL), you can perform the following operations on a cassette deck:

- ▶: Start playing.
- REW: Fast wind the tape from right to left.
- FF: Fast wind the tape from left to right.
- : Stop playing or recording.
- ||: Pause playing. To resume, press ▶.
- REC PAUSE: Enter recording pause by pressing this button. To start recording again, press this button then ▶.

MD recorder

After pressing TAPE/MD (or selecting "TAPE*" by pressing CONTROL repeatedly), you can perform the following operations on a MD recorder:



- ▶: Start playing.
- ◀◀: Return to the beginning of the current (or previous) track.
- ▶▶: Skip to the beginning of the next track.
- : Stop playing or recording.
- ||: Pause playing. To resume, press ▶.
- REC PAUSE: Enter recording pause by pressing this button. To start recording again, press this button then ▶.

* Selecting "TAPE" will allow you to control the MD recorder.

Note:

You can use either source selection buttons or the control button (CONTROL for RX-8030VBK or TAPE/CDR CONTROL for RX-7030VBK) to activate the buttons for the target source. If you press one of the source selection buttons, the playing source also changes. On the other hand, pressing the control button does not change the playing source.

Operating Video Components

IMPORTANT:

To operate JVC's video components using the supplied remote control:

- You need to connect JVC's video components through the AV COMPU LINK jacks (see page 42) in addition to the connections using cables with RCA pin plugs (see pages 14 and 15).
- Some JVC's VCRs can accept two types of the control signals—remote code "A" and "B." Before using this remote control, make sure that the remote control code of the target VCR is set to code "A."
 - For RX-8030VBK:** When another JVC's VCR is connected to the VCR 2 or VIDEO terminals, set its remote control code to code "B." (This remote control cannot emit the control signals of code "B.")
- When using the remote control, aim the remote control directly at the remote sensor on each component, not on the receiver.

For RX-8030VBK:

- When you press one of the source selection buttons, the operation mode appears on the display window.



| Buttons | Indications |
|-----------------------|---|
| VCR 1 | VCR 1 |
| DVD or DVD MULTI | DVD |
| TV/DBS | TV |
| CONTROL (repeatedly)* | <div style="display: flex; align-items: center; justify-content: center;"> } VCR 1 → TAPE } </div> <div style="display: flex; align-items: center; justify-content: center;"> { ← CDR { </div> <div style="display: flex; align-items: center; justify-content: center; margin-top: 5px;"> { CDDSC ← { </div> |

* By pressing CONTROL repeatedly, you can select "VCR 1," "TAPE," "CDR" or "CDDSC" as the source.

When you press one of the buttons listed above, the remote operation mode appears on the operation mode display for about two hours.

VCR

You can always perform the following operations:

VCR 1 ϕ /I (for RX-8030VBK) or VCR ϕ /I (for RX-7030VBK):
Turn on or off a VCR.

For RX-8030VBK: After pressing VCR 1 (or selecting "VCR 1" by pressing CONTROL repeatedly), you can perform the following operations on a VCR:

For RX-7030VBK: After pressing VCR (or VCR CONTROL), you can perform the following operations on a VCR:

- 1 – 9, 0: Select the TV channels on a VCR.
- ▶: Start playing.
- REW: Rewind a tape.
- FF: Fast wind a tape.
- : Stop playing or recording.
- ||: Pause playing. To resume, press ▶.
- REC PAUSE: Enter recording pause by pressing this button. To start recording again, press this button then ▶.
- CH +/-: Change the TV channels on the VCR.

Note:

You can use either VCR 1 (for RX-8030VBK) or VCR (for RX-7030VBK) or the control button (CONTROL for RX-8030VBK or VCR CONTROL for RX-7030VBK) to activate the buttons listed above. If you press one of the source selection buttons, the playing source also changes. On the other hand, pressing the control button does not change the playing source.

DVD player

After pressing DVD or DVD MULTI, you can perform the following operations on a DVD player:

- ▶: Start playing.
- ◀◀: Return to the beginning of the current (or previous) chapter.
- ▶▶: Skip to the beginning of the next chapter.
- : Stop playing.
- ||: Pause playing. To resume, press ▶.

After pressing DVD or DVD MULTI, these buttons can be used for the DVD menu operations.

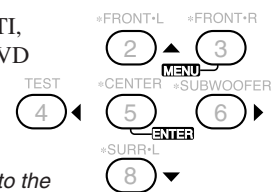

Note:

For detailed menu operations, refer to the instructions supplied with the discs or the DVD player.

TV

You can always perform the following operations:

- TV ϕ /I: Turn on or off the TV.
- TV VOL +/-: Adjust the volume.
- TV/VIDEO: Set the input mode (either TV or VIDEO).

After pressing TV/DBS, you can perform the following operations on a TV:

- CH +/-: Change the channels.
- 1 – 9, 0, 100+: Select the channels.
- RETURN: Alternate between the previously selected channel and the current channel.

Operating Other Manufacturers' Video Equipment

This remote control supplied with the receiver can transmit control signals for other manufacturers' TVs, CATV converters, DBS tuners, VCRs and DVD players.

When operating the other manufacturers' components, refer also to the manuals supplied with them.

- After replacing batteries for the remote control, you need to set the manufacturers' codes again.

To change the transmittable signals for operating another manufacturer's TV

1. Press and hold TV \odot/I .
2. Press TV/DBS.
For RX-8030VBK: "CALL" appears on the display window of the remote control.
3. Enter a manufacturer's code using buttons 1 – 9, and 0.
See the list on page 49 to find the code.
4. Release TV \odot/I .

The following buttons can be used for operating a TV:

- TV \odot/I : Turn on and off a TV.
TV VOL +/-: Adjust the volume.
TV/VIDEO: Set the input mode (either TV or VIDEO).

After pressing TV/DBS, you can perform the following operations on a TV:

- CH +/-: Change the channels.
1 – 10/0, 0, 100+ (+10):
Select the channels.
The 10/0 button will function as the ENTER button if your TV requires pressing ENTER after selecting a channel number.

Notes:

- All the functions listed above may not be assigned to the buttons for some TVs.
- If you cannot change the channels of some TVs by pressing 10 keys, press CH +/- for changing the channels.

5. Try to operate your TV by pressing TV \odot/I .

When your TV turns on or off, you have entered the correct code.

If there are more than one code listed for your brand of TV, try each one until the correct one is entered.

To change the transmittable signals for operating a CATV converter or DBS tuner

1. Press and hold CATV/DBS \odot/I .
2. Press CATV/DBS CONTROL.
For RX-8030VBK: "CALL" appears on the display window of the remote control.
3. Enter a manufacturer's code using buttons 1 – 9, and 0.
See the list on page 49 to find the code.
4. Release CATV/DBS \odot/I .

The following buttons can be used for operating a CATV converter and DBS tuner:

CATV/DBS \odot/I : Turn on and off a CATV converter or DBS tuner.

After pressing CATV/DBS CONTROL, you can perform the following operations on a CATV converter or DBS tuner:

- CH +/-: Change the channels.
1 – 10/0, 0, 100+ (+10):
Select the channels.
The 10/0 button will function as the ENTER button if your equipment requires pressing ENTER after selecting a channel number.

5. Try to operate your CATV converter or DBS tuner by pressing CATV/DBS \odot/I .

When your CATV converter or DBS tuner turns on or off, you have entered the correct code.

If there are more than one code listed for your brand of CATV converter or DBS tuner, try each one until the correct one is entered.

Note:

You cannot preset the signals for both the CATV converter and DBS tuner at the same time.

To change the transmittable signals for operating another manufacturer's VCR

1. Press and hold VCR 1 ϕ /I (for RX-8030VBK) or VCR ϕ /I (for RX-7030VBK).
2. Press VCR 1 (for RX-8030VBK) or VCR (for RX-7030VBK).

For RX-8030VBK: "CALL" appears on the display window of the remote control.

3. Enter manufacturer's code using buttons 1 – 9, and 0.

See the list on page 49 to find the code.

4. Release VCR 1 ϕ /I or VCR ϕ /I.

The following buttons can be used for operating a VCR:

VCR 1 ϕ /I: For RX-8030VBK—Turn on and off a VCR.
VCR ϕ /I: For RX-7030VBK—Turn on and off a VCR.

After pressing VCR 1 or VCR, you can perform the following operations on a VCR:

CH +/-: Change the TV channels on a VCR.
1 – 10/0, 0, 100+ (+10):

Select the TV channels.

The 10/0 button will function as the ENTER button if your VCR requires pressing ENTER after selecting a channel number.

- ▶: Start playback.
- REW: Rewind a tape.
- FF: Fast wind a tape.
- : Stop playing or recording.
- II: Pause playing. To resume, press ▶.
- REC PAUSE: Enter recording pause by pressing this button. To start recording again, press this button then ▶.

5. Try to operate your VCR by pressing VCR 1 ϕ /I or VCR ϕ /I.

When your VCR turns on or off, you have entered the correct code.

If there are more than one code listed for your brand of VCR, try each one until the correct one is entered.

To change the transmittable signals for operating another manufacturer's DVD player

1. Press and hold AUDIO ϕ /I.
2. Press DVD.
For RX-8030VBK: "CALL" appears on the display window of the remote control.
3. Enter a manufacturer's code using buttons 1 – 9, and 0.
See the list on page 49 to find the code.
4. Release AUDIO ϕ /I.

After pressing DVD or DVD MULTI, you can perform the following operations on a DVD player:

- ▶: Start playing.
- ◀◀: Return to the beginning of the current (or previous) chapter.
- ▶▶: Skip to the beginning of the next chapter.
- : Stop playing.
- II: Pause playing. To resume, press ▶.

After pressing DVD or DVD MULTI, these buttons can be used for the DVD menu operations.

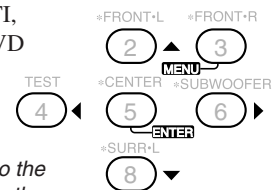

Note:

For detailed menu operations, refer to the instructions supplied with the discs or the DVD player.

5. Try to operate your DVD player by pressing one of the above buttons.

- DO NOT forget to turn on a DVD player before pressing one of the above buttons.

If there are more than one code listed for your brand of DVD, try each one until the correct one is entered.

For TV

| Manufacturer | Codes | Manufacturer | Codes |
|--------------|-------------------------|-----------------|--|
| JVC | 00*, 02, 13, 14, 47, 74 | Quelle | 52, 53, 54, 55, 56, 57, 58, 59, 60, 61, 62, 63, 64, 65, 66, 67 |
| Akai | 01, 02 | RCA/ Proscan | 08, 24, 29, 30, 31, 48 |
| Blaupunkt | 03, 04 | | SABA |
| Fisher | 01, 05 | Samsung | 06, 08, 16, 34, 35, 49 |
| Grundig | 03, 06, 07 | Sanyo | 01, 05 |
| Hitachi | 08, 09, 10, 49 | Schneider | 02, 15, 36 |
| Irradio | 02 | Sharp | 37, 38, 77 |
| ITT/NOKIA | 11, 12 | Sony | 39 |
| Loewe | 06, 15, 16 | Telefunken | 40, 41, 42, 69 |
| Magnavox | 08, 17, 49 | Thomson | 71, 72 |
| Mets | 50, 51, 52, 53 | Toshiba | 37, 43, 44 |
| Mitsubishi | 08, 18, 19, 20 | Zenith | 45, 46 |
| Mivar | 21 | | |
| Nordmende | 22, 23 | | |
| Okano | 15 | | |
| Panasonic | 24, 25, 26, 27, 76 | | |
| Philips | 15, 17, 28, 75 | | |

For VCR

| Manufacturer | Codes |
|---------------|--------------------------------|
| JVC | 00*, 26, 27, 28, 29, 58 |
| Aiwa | 01, 02 |
| Bell & Howell | 03 |
| Blaupunkt | 04, 05 |
| CGM | 06, 07 |
| Emerson | 08, 10, 11, 12, 64, 65 |
| Fisher | 03, 14, 15, 16, 17 |
| Funai | 01 |
| GE | 18, 19, 20 |
| Goldstar | 07 |
| Goodmans | 13, 21 |
| Grundig | 06, 22 |
| Hitachi | 18, 23, 24, 25, 66 |
| Loewe | 07, 21 |
| Magnavox | 04, 19, 24 |
| Mitsubishi | 30, 31, 32, 33, 34, 35 |
| NEC | 26, 27 |
| Nokia | 03, 36 |
| Nordmende | 38 |
| Orion | 09 |
| Panasonic | 19, 24, 39, 40 |
| Philips | 04, 19, 21, 24, 41, 42 |
| Phonola | 21 |
| RCA/Proscan | 04, 18, 19, 23, 24, 43, 44, 45 |
| SABA | 38, 46 |
| Samsung | 45, 47, 59, 61, 62, 63 |
| Sanyo | 03, 48, 49 |
| Sharp | 37, 50 |
| Siemens | 03, 51 |
| Sony | 52, 53, 54 |
| Telefunken | 55, 60 |
| Toshiba | 43, 44 |
| Zenith | 56, 57 |

For DBS tuner

| Manufacturer | Codes |
|--------------|----------------------------|
| JVC | 56*, 57, 67 |
| Amstrad | 43, 44, 45, 46, 47, 48, 49 |
| Blaupunkt | 30 |
| Echostar | 50, 51, 67 |
| Goldstar | 31 |
| Grundig | 32, 33 |
| Hirshmann | 48, 52, 53, 54, 55 |
| Instrument | 68 |
| ITT/NOKIA | 34 |
| Kathrein | 52, 58, 59, 60, 61, 62, 63 |
| NEC | 35, 36 |
| Orbitech | 48 |
| Philips | 37, 38 |
| RCA | 65 |
| Samsung | 39, 40 |
| Schwaiger | 61, 64 |
| Siemens | 41, 42 |
| Sony | 66 |
| Technisat | 48 |

For CATV converter

| Manufacturer | Codes |
|--------------------|--|
| General Instrument | 06, 07, 08, 09, 10, 11, 12, 13, 14, 29 |
| Hamlin/Regal | 01, 02, 03, 04, 05 |
| Jerrold | 06, 07, 08, 09, 10, 11, 12, 13, 14 |
| Oak | 15, 16, 17 |
| Panasonic | 18, 19, 20 |
| Pioneer | 21, 22 |
| Scientific Atlanta | 23, 24, 25 |
| Tocom | 26 |
| Zenith | 27, 28 |

For DVD player



| Manufacturer | Codes |
|--------------|------------|
| JVC | 00*, 02 |
| Denon | 01 |
| Panasonic | 03 |
| Philips | 13 |
| Pioneer | 04, 05, 06 |
| RCA | 07 |
| Samsung | 08 |
| Sony | 09 |
| Toshiba | 10 |
| Yamaha | 11, 12 |

*Initial setting

Manufacturers' codes are subject to change without notice. If they are changed, this remote control cannot operate the equipment.

Troubleshooting

Use this chart to help you solve daily operational problems. If there is any problem you cannot solve, contact your JVC's service center.

| PROBLEM | POSSIBLE CAUSE | SOLUTION |
|---|---|--|
| The display does not light up. | The power cord is not plugged in. | Plug the power cord into an AC outlet. |
| No sound from speakers. | Speaker signal cables are not connected. | Check speaker wiring and reconnect if necessary. (See pages 9 to 11.) |
| | The SPEAKERS ON/OFF 1 and SPEAKERS ON/OFF 2 buttons are not set correctly. | Press SPEAKERS ON/OFF 1 and SPEAKERS ON/OFF 2 correctly. (See page 19.) |
| | An incorrect source is selected. | Select the correct source. |
| | Muting is activated. | Press MUTING to cancel the mute. (See page 22.) |
| | An incorrect input mode (analog or digital) is selected. | Select the correct input mode (analog or digital). (See page 19.) |
| Sound from one speaker only. | Speaker signal cables are not connected properly. | Check speaker wiring and reconnect if necessary. (See pages 9 to 11.) |
| Continuous hiss or buzzing during FM reception. | Incoming signal is too weak. | Connect an outdoor FM antenna or contact your dealer. (See page 8.) |
| | The station is too far away. | Select a new station. |
| | An incorrect antenna is used. | Check with your dealer to be sure you have the correct antenna. |
| Noise is heard during FM/AM reception. | Antennas are not connected properly. | Check connections. (See page 8.) |
| | Ignition noise from automobiles. | Move the antenna farther from automobile traffic. |
| Howling during record playing. | A ground cable from the turntable is not connected to the screw marked (⌘) on the rear. | Connect the cable to the screw marked (⌘) on the rear. |
| | Your turntable is too close to the speakers. | Move the speakers away from the turntable. |
| No sound effect such as Surround mode, DSP mode and Digital Equalization. | Analog Direct is turned on. | Turn off Analog Direct. (See page 21.) |
| | DVD MULTI is selected as the source. | Select the source other than DVD MULTI. (See page 40.) |
| EX/ES (7.1-channel) reproduction cannot be done for Dolby Digital EX or DTS ES software. | Software or setting is not for Dolby Digital EX or DTS ES software. | Play back software bearing the mark  or  . Set "EX/ES" setting to "ON." (See page 37.) |
| "OVERLOAD" starts flashing on the display. | Speakers are overloaded because of high volume. | 1. Press  STANDBY/ON on the front panel to turn off the receiver. 2. Stop the playback source. 3. Turn on the receiver again, and adjust the volume. |
| | Speakers are overloaded because of short circuit of speaker terminals. | Press  STANDBY/ON on the front panel to turn off the receiver, then check the speaker wiring. If "OVERLOAD" does not disappear, unplug the AC power cord, then plug it back again. If speaker wiring is not short-circuited, contact your dealer. |
| The STANDBY lamp lights up after turning on the power, and soon the receiver turns off again (into standby mode). | The receiver is overloaded because of a high voltage. | Press  STANDBY/ON on the front panel to turn off the receiver. After unplugging the AC power cord, consult your dealer. |
| Remote control does not work. | There is an obstruction between the remote sensor on the receiver and the remote control. | Remove the obstruction. |
| | Batteries are weak. | Replace batteries. (See page 8.) |
| Remote control does not work as you intend. | An incorrect remote control operation mode is selected. | Select the correct remote control operation mode. (See pages 44 to 49.) |

RX-8030VBK

Amplifier

Output Power

At Stereo operation

Front ch: **130 W per channel, min. RMS, driven into 8 Ω, 20 Hz to 20 kHz, with no more than 0.08% total harmonic distortion.**

At Surround operation:

Front ch: 130 W per channel, min. RMS, driven into 8 Ω at 1 kHz, with no more than 0.8% total harmonic distortion.

Center ch: 130 W, min. RMS, driven into 8 Ω at 1 kHz, with no more than 0.8% total harmonic distortion.

Surround ch: 130 W per channel, min. RMS, driven into 8 Ω at 1 kHz, with no more than 0.8% total harmonic distortion.

Surround Back ch: 130 W, min. RMS, driven into 8 Ω at 1 kHz, with no more than 0.8% total harmonic distortion.

Audio

Audio Input Sensitivity/Impedance (1 kHz)

PHONO IN (MM): 2.5 mV/47 kΩ

DVD IN, VCR 1 IN, VCR 2 IN, TV SOUND/DBS IN, VIDEO IN: 200 mV/47 kΩ

CD IN, CDR IN, TAPE/MD IN: 200 mV/47 kΩ

Audio Input (DIGITAL IN)*

Coaxial: DIGITAL 1 (DVD): 0.5 V(p-p)/75 Ω

Optical: DIGITAL 2 (CD), DIGITAL 3 (TV), DIGITAL 4 (CDR): -21 dBm to -15 dBm (660 nm ±30 nm)

* Corresponding to Linear PCM, Dolby Digital, and DTS Digital Surround (with sampling frequency — 32 kHz, 44.1 kHz, 48 kHz).

Audio Output Level: PRE OUT: 1 V

Recording Output Level: VCR 1 OUT, VCR 2 OUT, CDR OUT, TAPE/MD OUT: 200 mV

Digital output: Optical: DIGITAL OUTPUT
Signal wave length: 660 nm
Output level: -21 dBm to -15 dBm

Signal-to-Noise Ratio ('66 IHF/'78 IHF)

PHONO IN: 70 dB/78 dB (at REC OUT)

DVD IN, VCR 1 IN, VCR 2 IN, TV SOUND/DBS IN, VIDEO: 87 dB/80 dB

CD IN, CDR IN, TAPE/MD IN: 87 dB/80 dB

Frequency Response (8 Ω)

PHONO IN: 20 Hz to 20 kHz (±1 dB)

DVD IN, VCR 1 IN, VCR 2 IN, TV SOUND/DBS IN, VIDEO: 20 Hz to 100 kHz (+1 dB, -3 dB)

CD IN, CDR IN, TAPE/MD IN: 20 Hz to 100 kHz (+1 dB, -3 dB)

RIAA Phono Equalization: ±1.0 dB (20 Hz to 20 kHz)

Equalization (5 bands):

63 Hz, 250 Hz, 1 kHz, 4 kHz, 16 kHz (±8 dB)

Bass boost: +6 dB ±1.0 dB at 100 Hz

Video

Video Input Sensitivity/Impedance

Composite video:

DVD IN, VCR 1 IN, VCR 2 IN, TV SOUND/DBS IN, VIDEO: 1 V(p-p)/75 Ω

S-video:

DVD IN, VCR 1 IN, VCR 2 IN, TV SOUND/DBS IN, VIDEO:
(Y: luminance): 1 V(p-p)/75 Ω
(C: chrominance, burst): 0.286 V(p-p)/75 Ω

Component video: DVD IN, DBS IN:

(Y: luminance): 1 V(p-p)/75 Ω
(Pb/Pr): 0.7 V(p-p)/75 Ω

Video Output Level

Composite video:

VCR 1 OUT, VCR 2 OUT, MONITOR OUT 1 V(p-p)/75 Ω

S-video: VCR 1 OUT, VCR 2 OUT, MONITOR OUT

(Y: luminance): 1 V(p-p)/75 Ω
(C: chrominance, burst): 0.286 V(p-p)/75 Ω

Component video: MONITOR OUT:

(Y: luminance): 1 V(p-p)/75 Ω
(Pb/Pr): 0.7 V(p-p)/75 Ω

Synchronization:

Signal-to-Noise Ratio: Negative 45 dB

FM tuner (IHF)

Tuning Range: 87.5 MHz to 108.0 MHz

Usable Sensitivity: Monaural: 12.8 dBf (1.2 μV/75 Ω)

50 dB Quieting Sensitivity: Monaural: 16.0 dBf (1.7 μV/75 Ω)

Stereo: 37.5 dBf (20.5 μV/75 Ω)

Stereo Separation at REC OUT: 35 dB at 1 kHz

AM tuner

Tuning Range: 530 kHz to 1 710 kHz

General

Power Requirements: AC 120V~, 60 Hz

Power Consumption: 320 W/440 VA (at operation)
2 W (in standby mode)

Dimensions (W x H x D): 435 mm x 157 mm x 425 mm
(17 3/16 in. x 6 3/16 in. x 16 3/4 in.)

Mass: 12.2 kg (27.0 lbs)

Designs & specifications are subject to change without notice

RX-7030VBK**Amplifier**

Output Power

At Stereo operation

Front ch: **110 W per channel, min. RMS, driven into 8 Ω, 20 Hz to 20 kHz, with no more than 0.08% total harmonic distortion.**

At Surround operation:

Front ch: 110 W per channel, min. RMS, driven into 8 Ω at 1 kHz, with no more than 0.8% total harmonic distortion.

Center ch: 110 W, min. RMS, driven into 8 Ω at 1 kHz, with no more than 0.8% total harmonic distortion.

Surround ch: 110 W per channel, min. RMS, driven into 8 Ω at 1 kHz, with no more than 0.8% total harmonic distortion.

Surround Back ch: 110 W, min. RMS, driven into 8 Ω at 1 kHz, with no more than 0.8% total harmonic distortion.

Audio

Audio Input Sensitivity/Impedance (1 kHz)

DVD IN, VCR IN, TV SOUND/DBS IN: 200 mV/47 kΩ

CD IN, TAPE/CDR IN: 200 mV/47 kΩ

Audio Input (DIGITAL IN)*

Coaxial: DIGITAL 1 (DVD): 0.5 V(p-p)/75 Ω

Optical: DIGITAL 2 (CD), DIGITAL 3 (TV), DIGITAL 4 (CDR):
-21 dBm to -15 dBm (660 nm ±30 nm)

* Corresponding to Linear PCM, Dolby Digital, and DTS Digital

Surround (with sampling frequency — 32 kHz, 44.1 kHz, 48 kHz).

Audio Output Level: SUBWOOFER OUT: 1 V

Recording Output Level: VCR OUT, TAPE/CDR OUT: 200 mV

Digital output: Optical: DIGITAL OUT
Signal wave length: 660 nm
Output level: -21 dBm to -15 dBm

Signal-to-Noise Ratio ('66 IHF/'78 IHF)

DVD IN, VCR IN, TV SOUND/DBS IN: 87 dB/80 dB

CD IN, TAPE/CDR IN: 87 dB/80 dB

Frequency Response (8 Ω)

DVD IN, VCR IN, TV SOUND/DBS IN:
20 Hz to 100 kHz (+1 dB, -3 dB)

CD IN, TAPE/CDR IN: 20 Hz to 100 kHz (+1 dB, -3 dB)

Equalization (5 bands):

63 Hz, 250 Hz, 1 kHz, 4 kHz, 16 kHz (±8 dB)

Bass boost: +6 dB ±1.0 dB at 100 Hz

Video

Video Input Sensitivity/Impedance

Composite video: DVD IN, VCR IN, TV SOUND/DBS IN:
1 V(p-p)/75 Ω

S-video: DVD IN, VCR IN, TV SOUND/DBS IN:
(Y: luminance): 1 V(p-p)/75 Ω
(C: chrominance, burst): 0.286 V(p-p)/75 Ω

Component video: DVD IN, DBS IN:
(Y: luminance): 1 V(p-p)/75 Ω
(Pb/Pr): 0.7 V(p-p)/75 Ω

Video Output Level

Composite video: VCR OUT, MONITOR OUT 1 V(p-p)/75 Ω

S-video: VCR OUT, MONITOR OUT
(Y: luminance): 1 V(p-p)/75 Ω
(C: chrominance, burst): 0.286 V(p-p)/75 Ω

Component video: MONITOR OUT
(Y: luminance): 1 V(p-p)/75 Ω
(Pb/Pr): 0.7 V(p-p)/75 Ω

Synchronization: Negative

Signal-to-Noise Ratio: 45 dB

FM tuner (IHF)

Tuning Range: 87.5 MHz to 108.0 MHz

Usable Sensitivity: Monaural: 12.8 dBf (1.2 μV/75 Ω)

50 dB Quieting Sensitivity: Monaural: 16.0 dBf (1.7 μV/75 Ω)

Stereo: 37.5 dBf (20.5 μV/75 Ω)

Stereo Separation at REC OUT: 35 dB at 1 kHz

AM tuner

Tuning Range: 530 kHz to 1 710 kHz

General

Power Requirements: AC 120V~, 60 Hz

Power Consumption: 320 W/440 VA (at operation)

2 W (in standby mode)

Dimensions (W x H x D): 435 mm x 157 mm x 425 mm

(17 ³/₁₆ in. x 6 ³/₁₆ in. x 16 ³/₄ in.)

Mass: 12.1 kg (26.7 lbs)

Designs & specifications are subject to change without notice

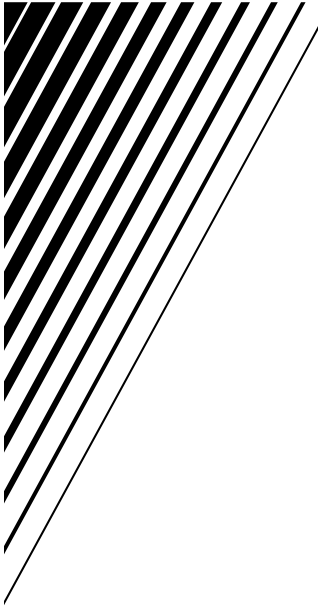

JVC
VICTOR COMPANY OF JAPAN, LIMITED